

CORREDERA DOMO 85RT

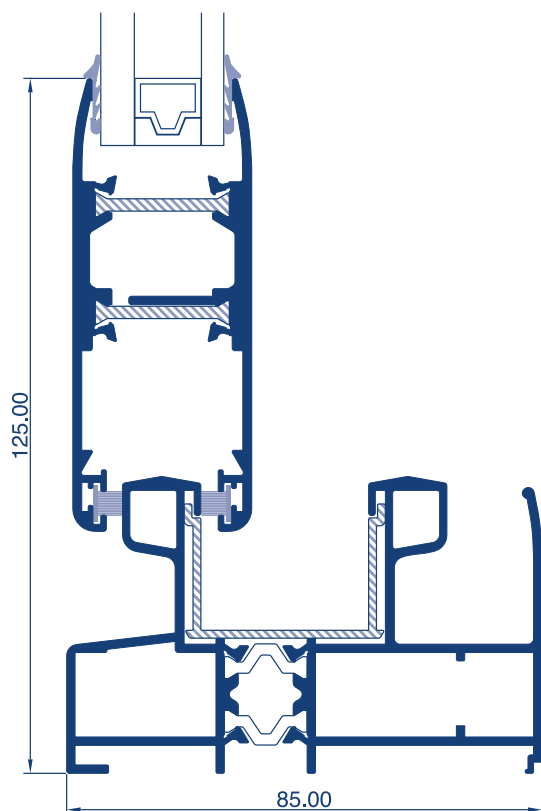

CARACTERÍSTICAS

- Rotura puente térmico.
- Corte a inglete
- Corredera perimetral.
- Perfiles en extrusión de aleación 6063.
- Espesor general 1.6 mm.
- Acristalamiento con juntas de E.P.D.M.
- Juntas de polipelo.
- Escuadras de unión de aluminio inyectado con muelle y tetón.
- Escuadras de alineamiento en acero Inox.
- Profundidad de marco 85 mm.
- Profundidad de hoja 32 mm.
- Conexión sólida mecánica de poliamida de alta resistencia.
- Posibilidad de diferentes tipos de cierres; embutidos con o sin llave.
- Cierre de tres puntos.



INDALSU 2011

EN 14351-1
LGAI Technological Center, S.A.
(APPLUS) Organismo Notificado N°0370

Sistema DOMO 85RT PERIMETRAL, ventana
corredera de dos hojas y medidas $\leq 2,7\text{m}^2$
Acristalamiento 6/12/4 B.E.

Resistencia a la carga de viento	Clase C5
Permeabilidad al aire	Clase 3
Estanqueidad al agua	8A
Sustancias peligrosas	NPD
Capacidad de soporte de carga de los dispositivos de seguridad	
Prestaciones acústicas	29 (-1,-2)
Transmitancia térmica (U_w)	3,1 W/m ² K

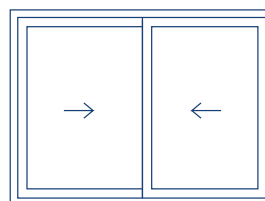

Corredera

CORREDERA DOMO 85RT

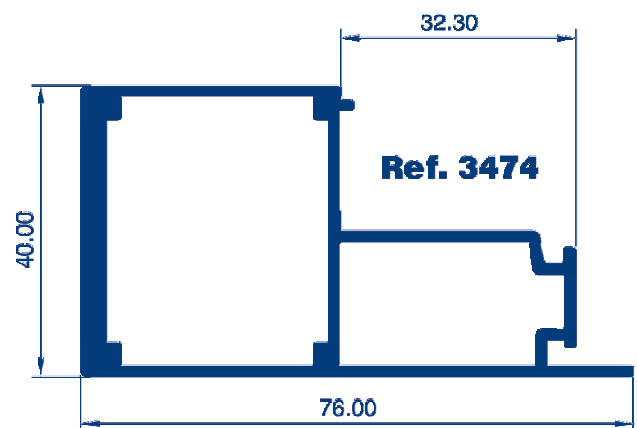
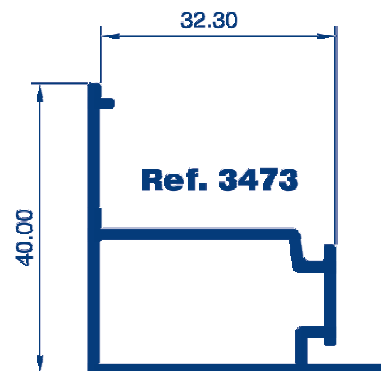
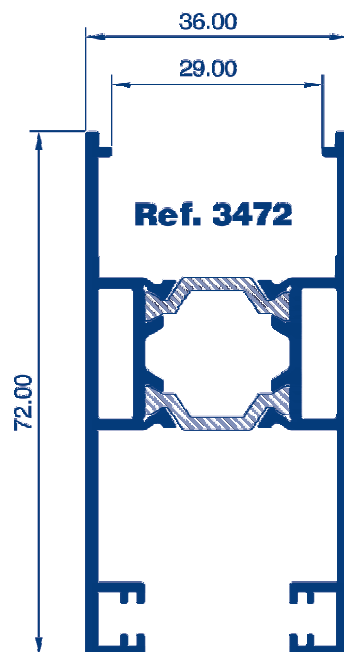
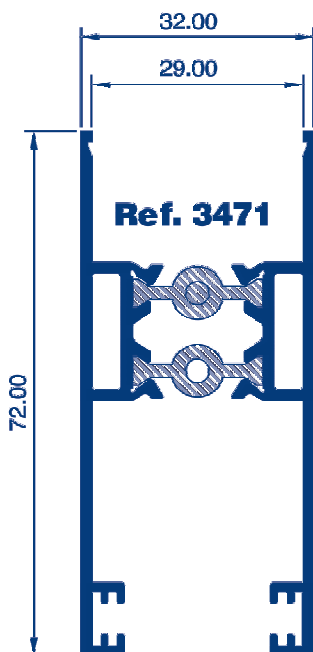
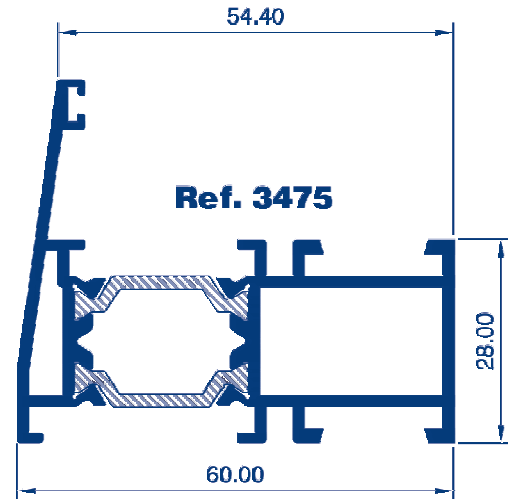
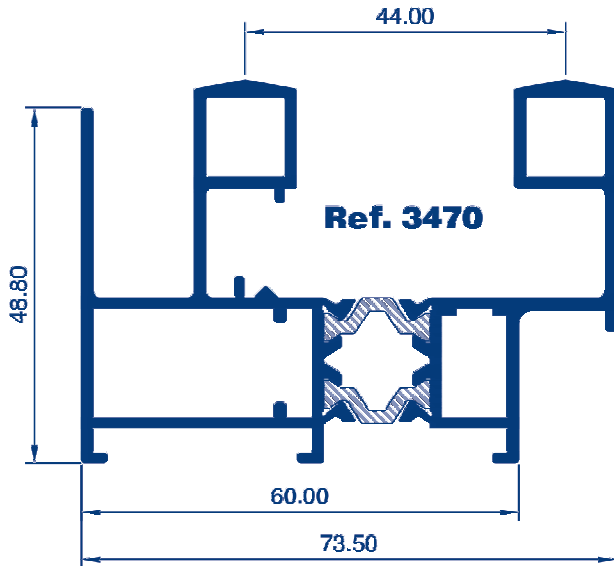

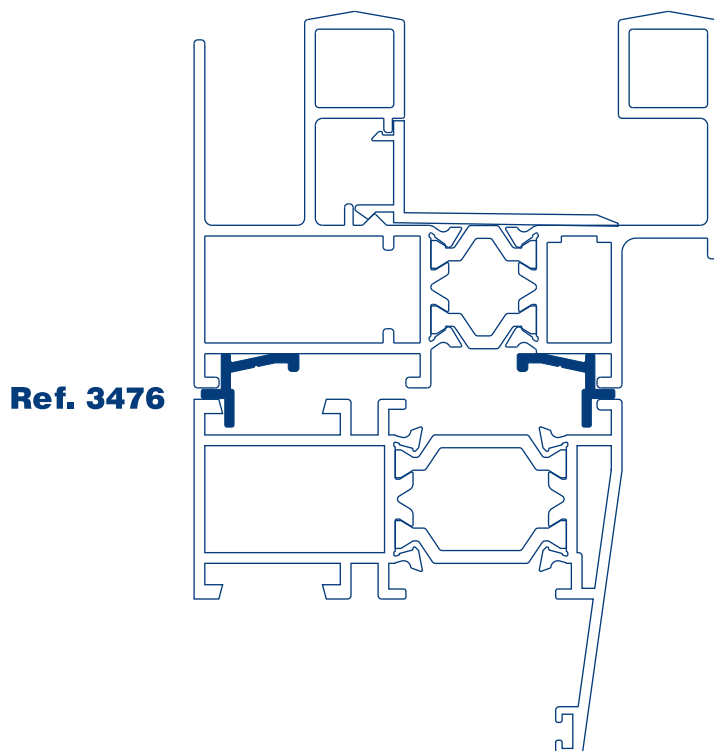
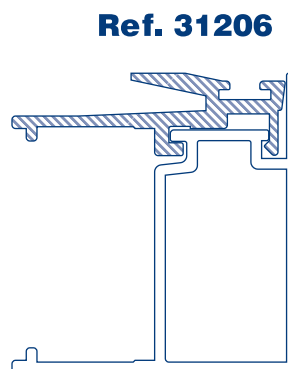
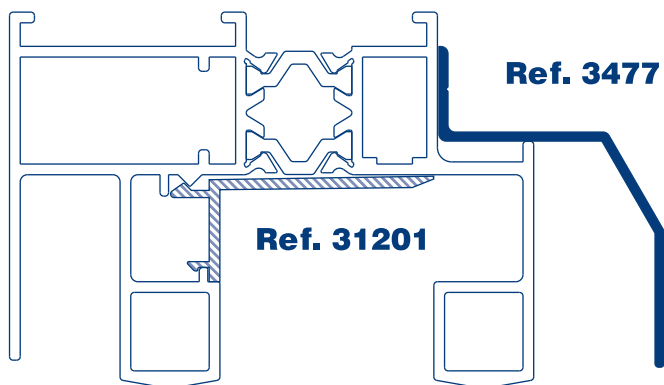

CORREDERA DOMO 85RT

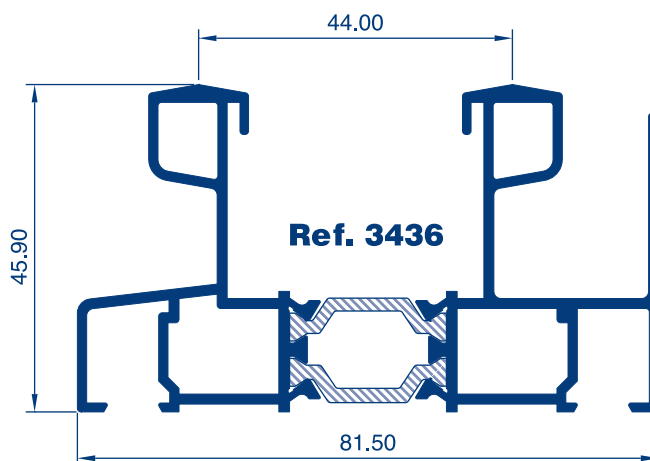
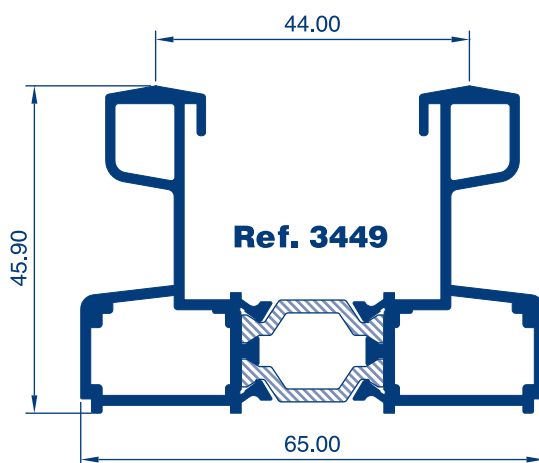
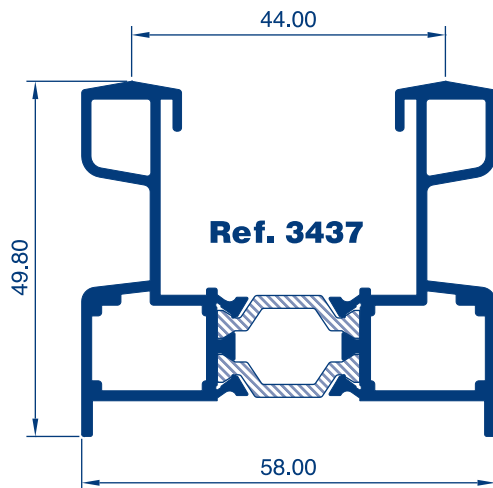

CORREDERA DOMO 85RT

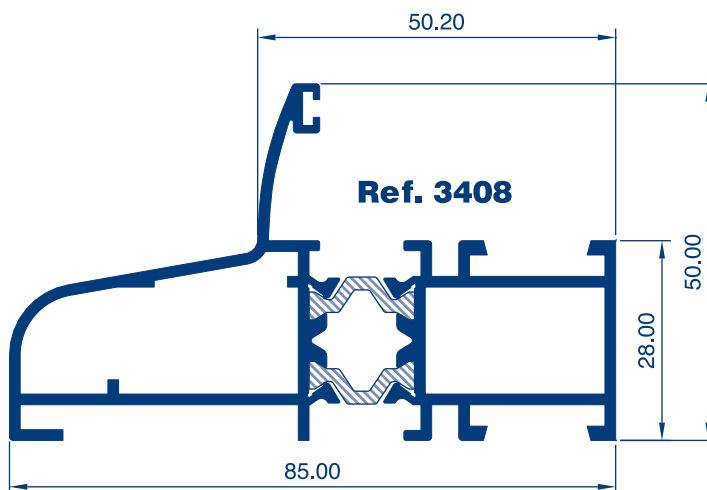
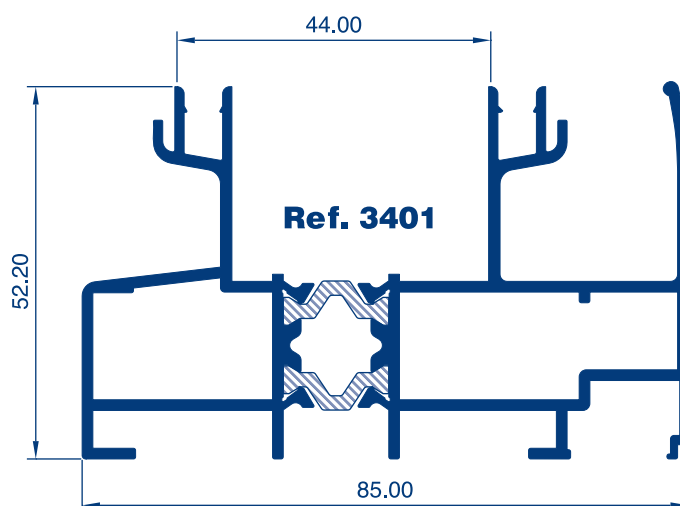
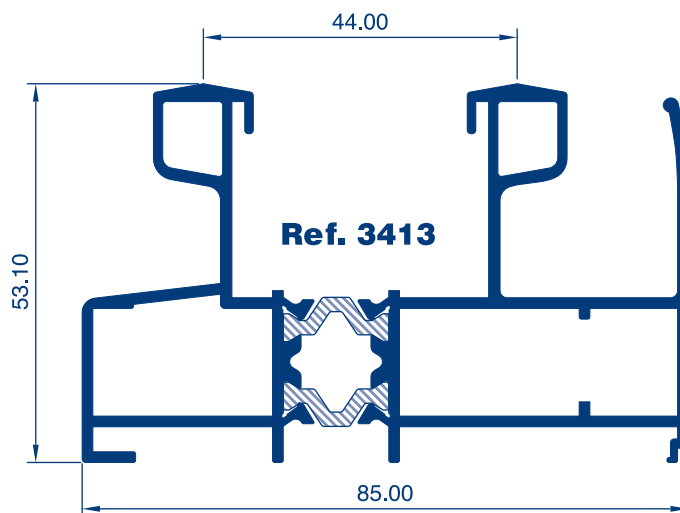

CORREDERA DOMO 85RT

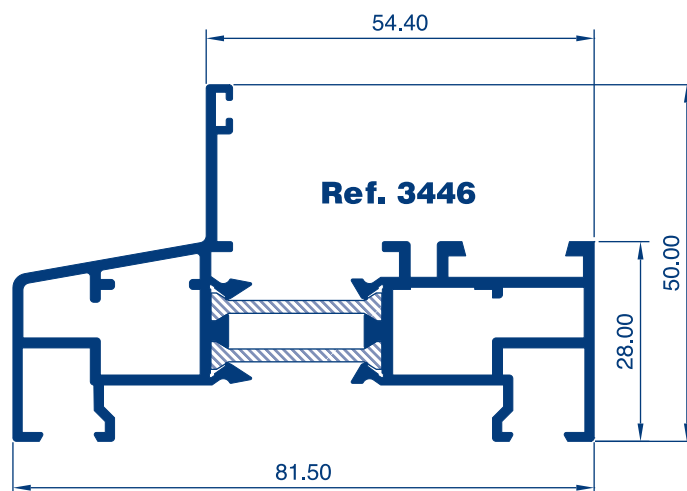
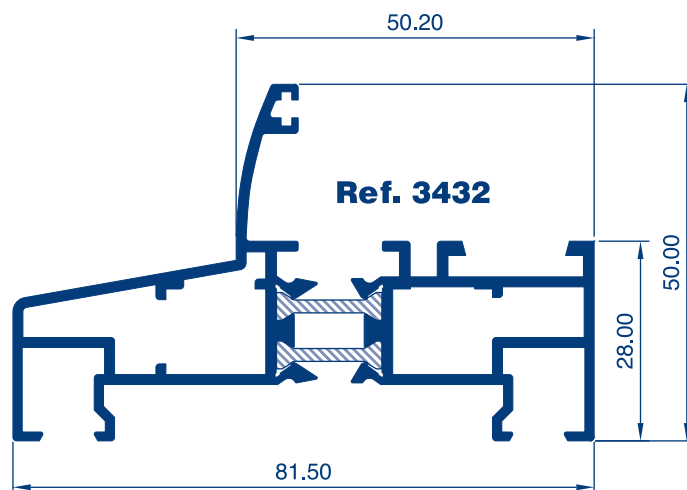
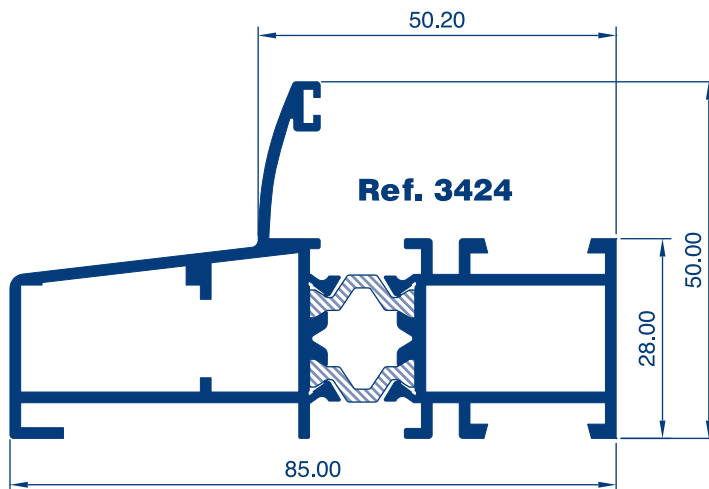

CORREDERA DOMO 85RT

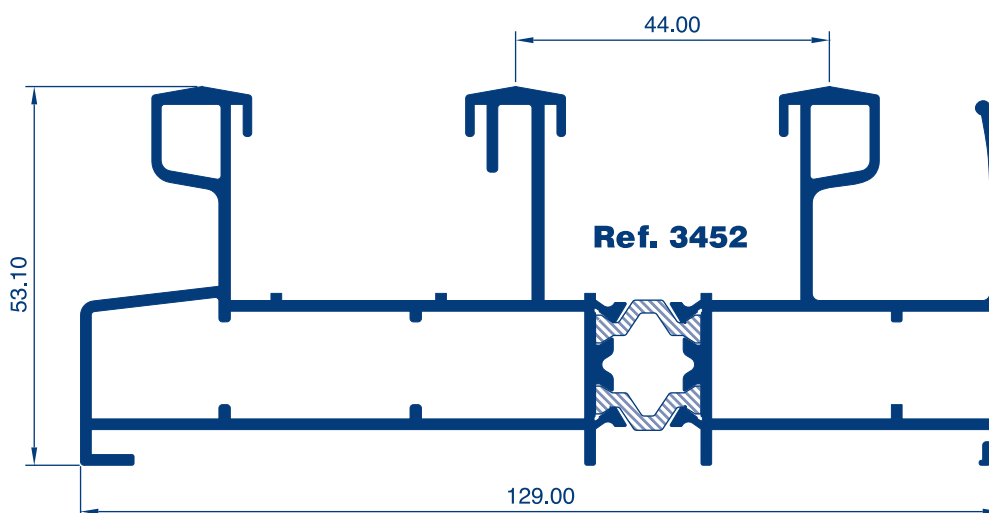
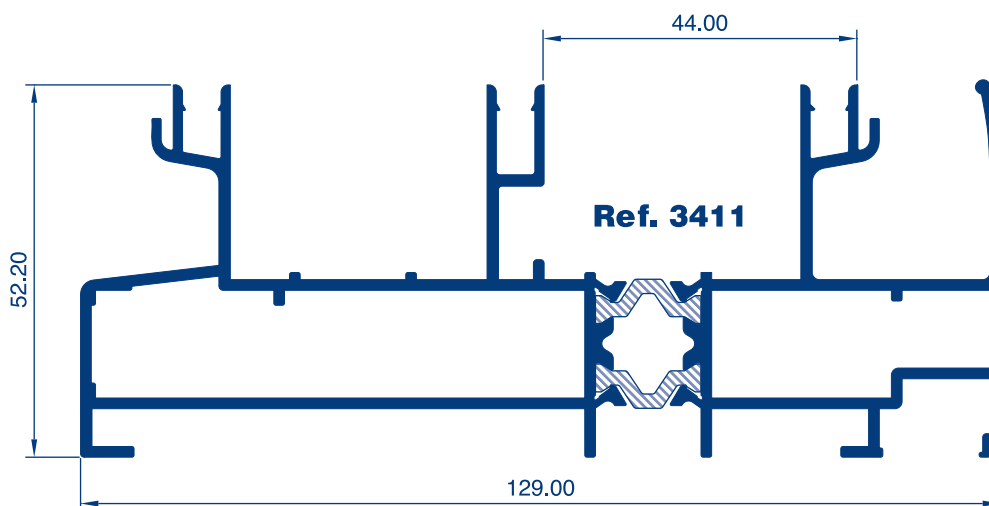

CORREDERA DOMO 85RT

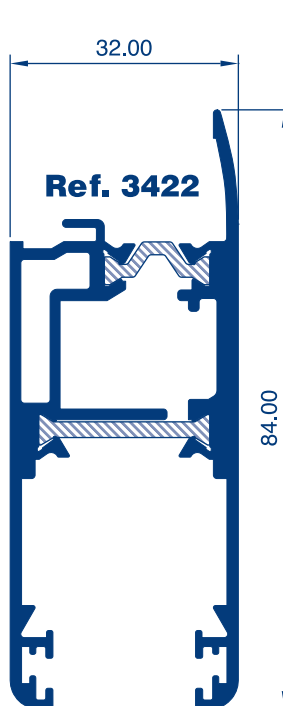
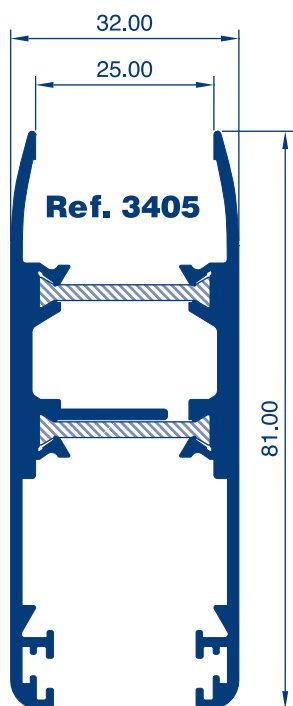
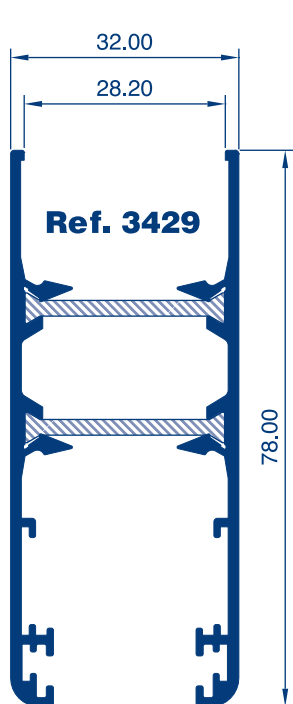

CORREDERA DOMO 85RT

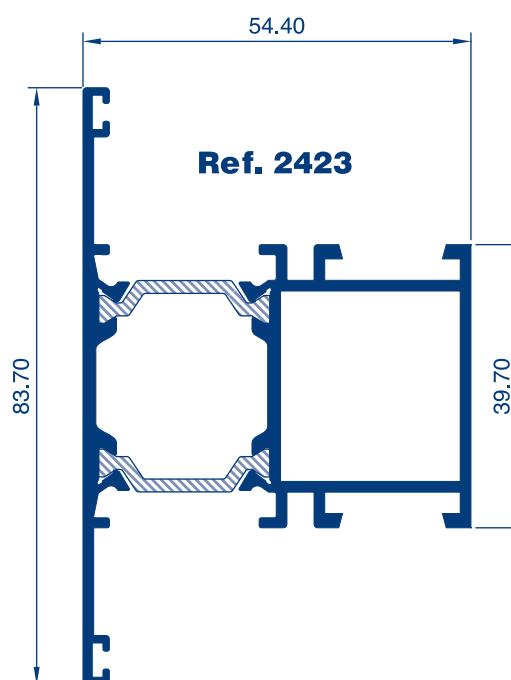
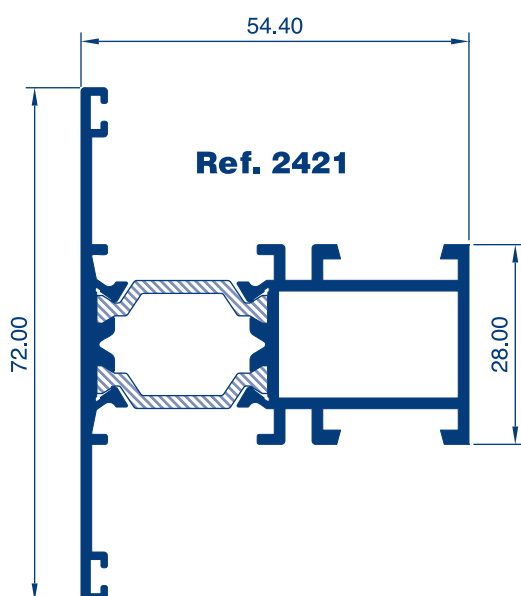
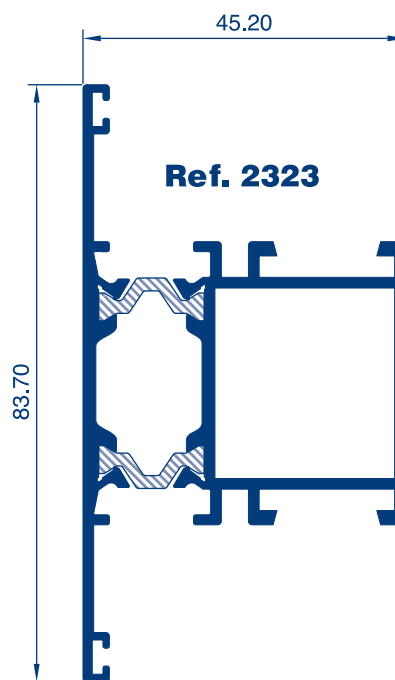
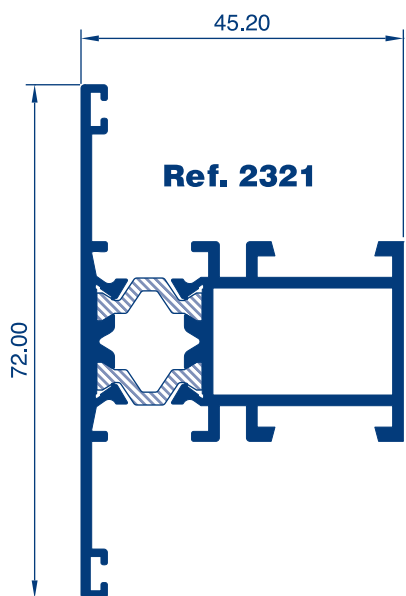

CORREDERA DOMO 85RT

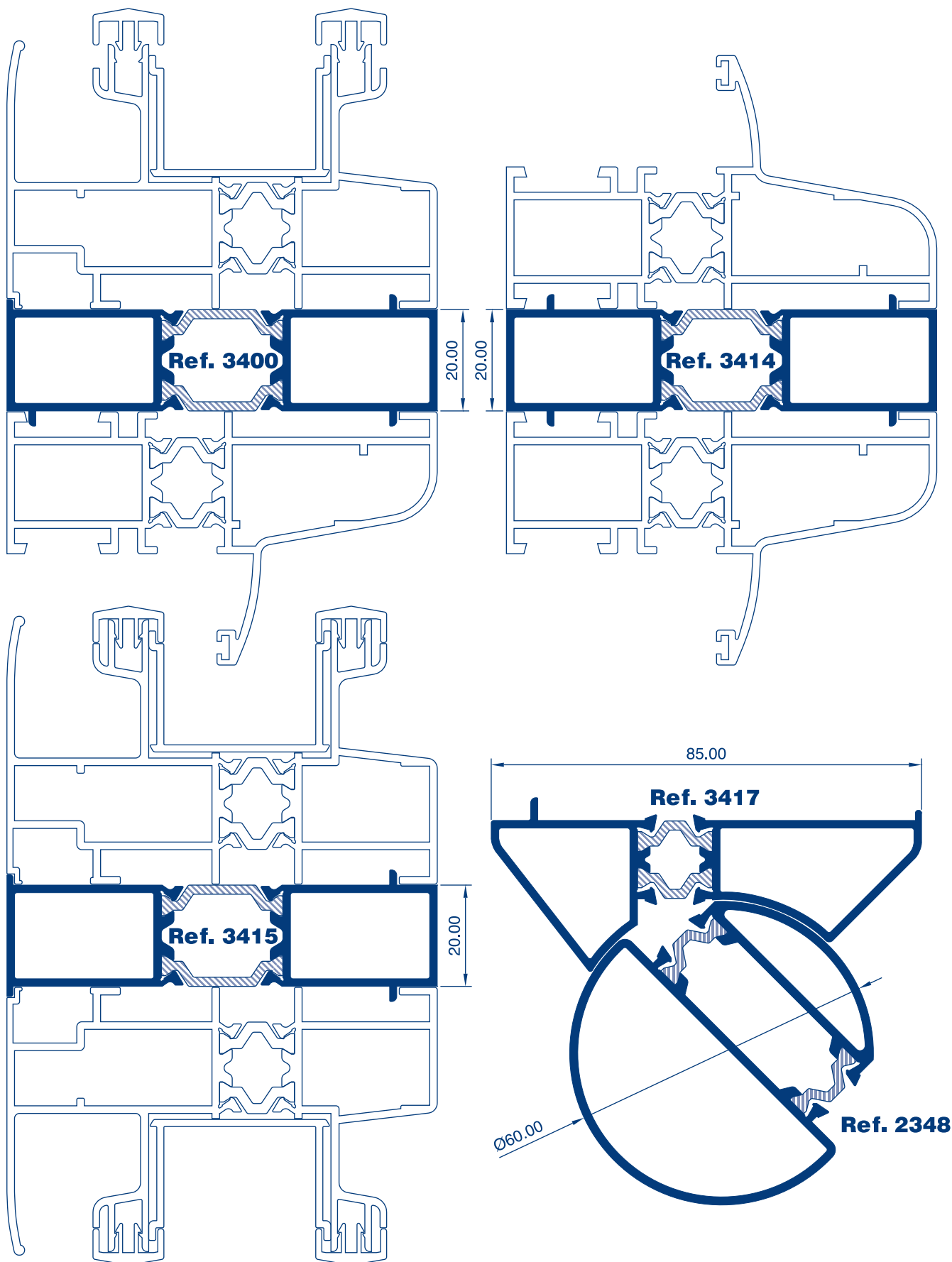

CORREDERA DOMO 85RT

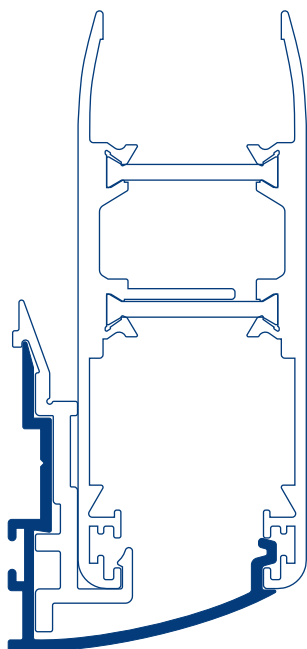

Ref. 3409

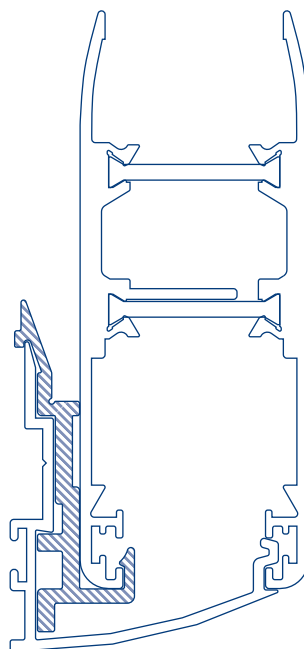

Ref. 31205

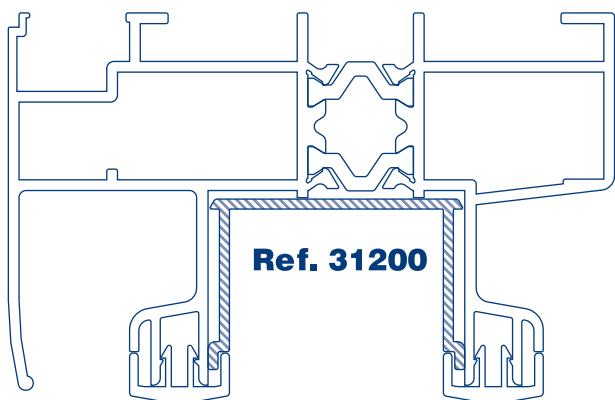

Ref. 31200

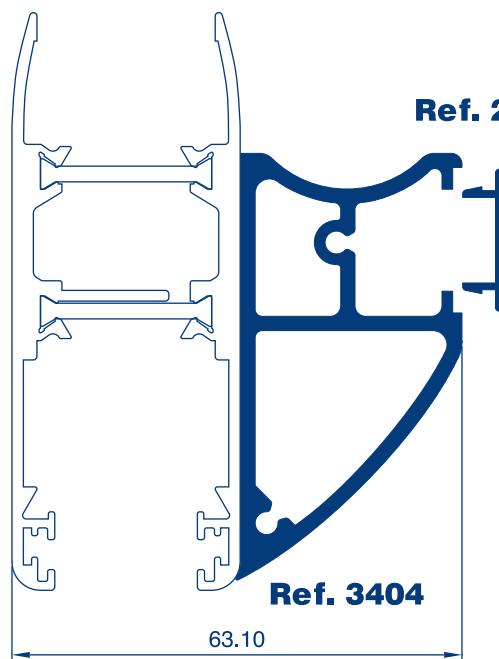

Ref. 2605

Ref. 3404

63.10

CORREDERA DOMO 85RT

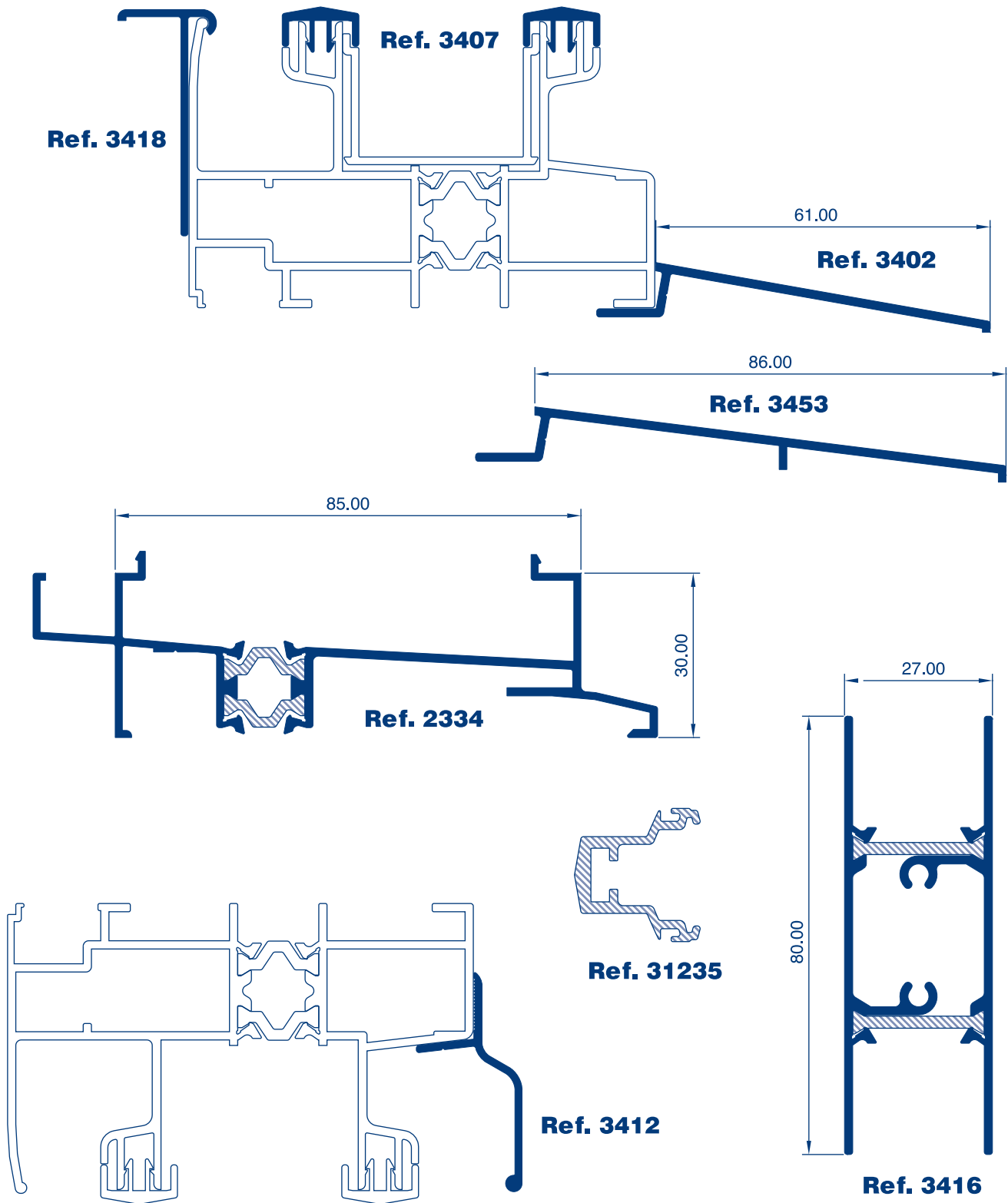

CORREDERA DOMO 85RT

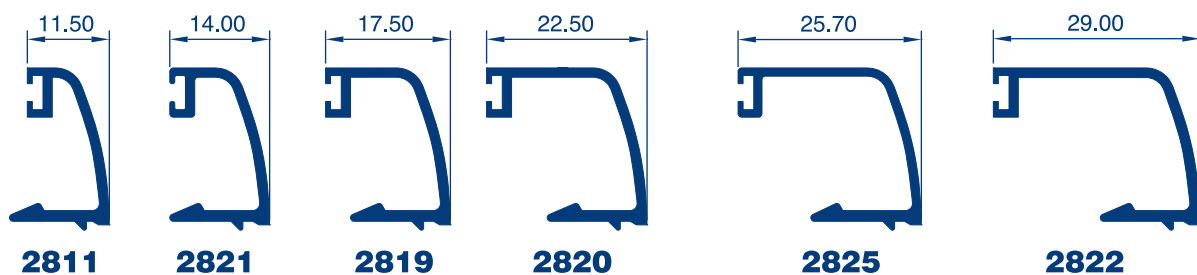
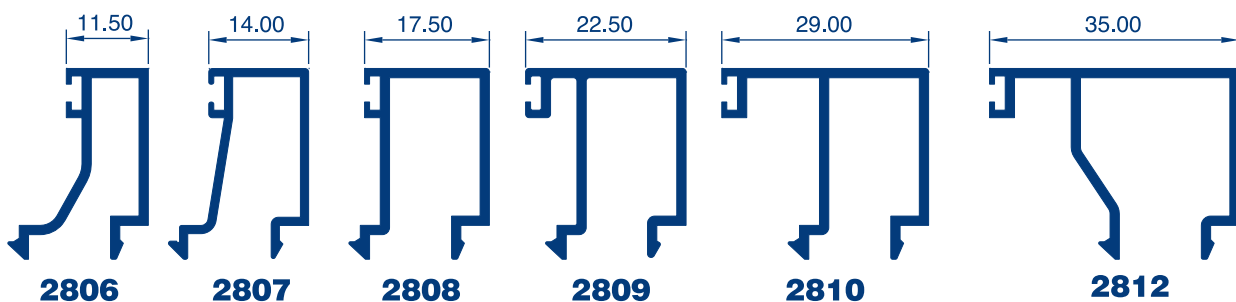
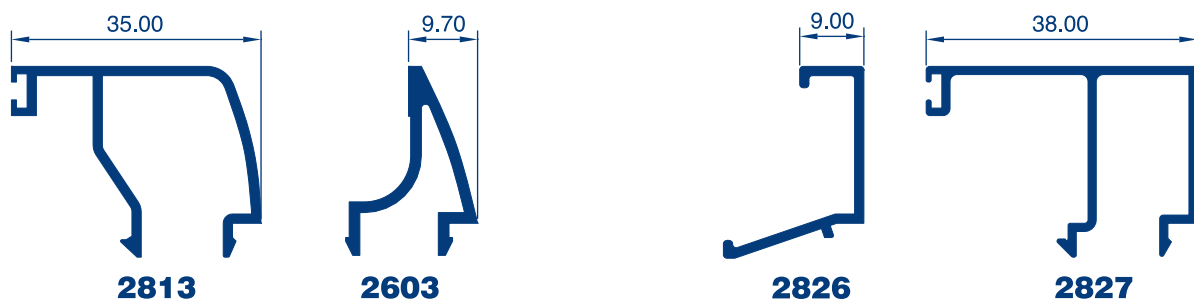
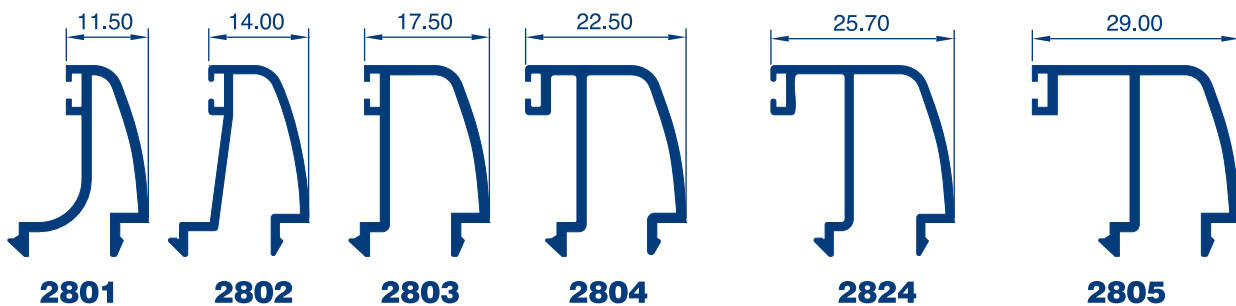



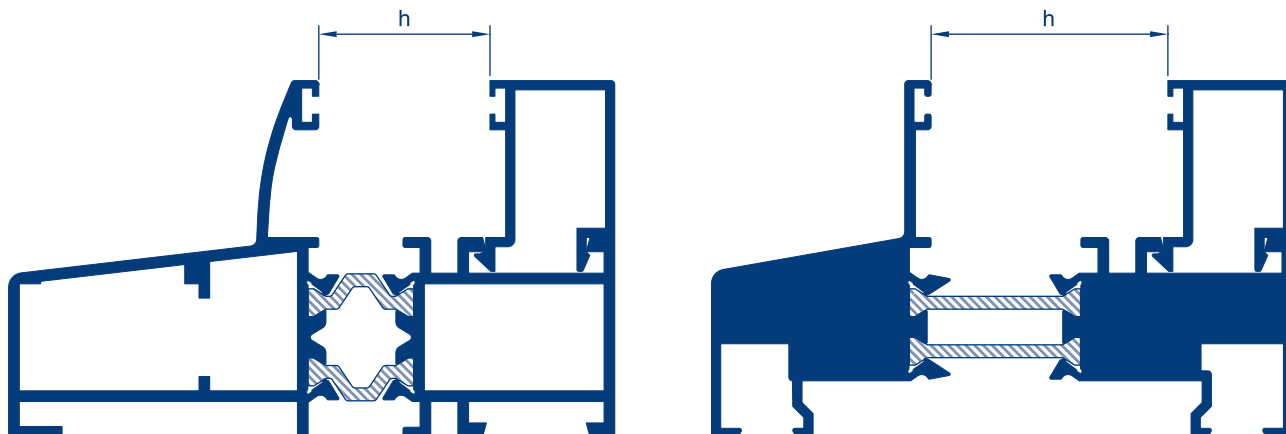

CORREDERA DOMO 85RT





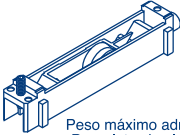
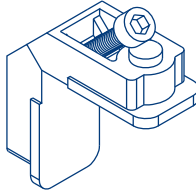
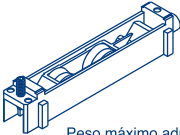
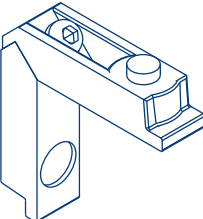
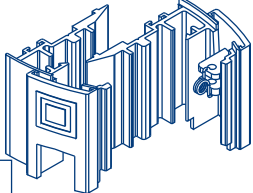
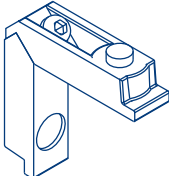
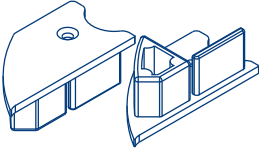
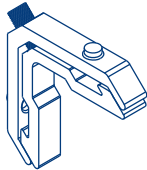
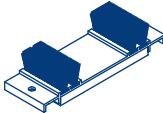

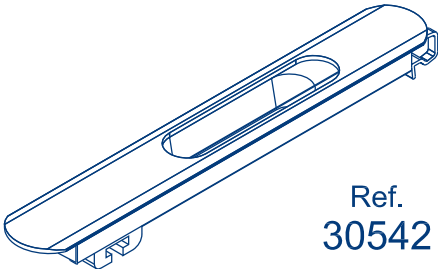

Con marcos y travesaños DOMO 45RT			Con marcos y travesaños DOMO 60RT		
Junquillo		Hueco (h)	Junquillo		Hueco (h)
recto	2826 (9mm)	32 mm	recto	2826 (9mm)	41 mm
curvo	2801 (11.5mm)	29 mm	curvo	2801 (11.5mm)	38 mm
recto	2806 (11.5mm)	29 mm	recto	2806 (11.5mm)	38 mm
curvo	2802 (14mm)	26.5 mm	curvo	2802 (14mm)	36 mm
recto	2807 (14mm)	26.5 mm	recto	2807 (14mm)	36 mm
curvo	2803 (17.5mm)	23 mm	curvo	2803 (17.5mm)	32 mm
recto	2808 (17.5mm)	23 mm	recto	2808 (17.5mm)	32 mm
curvo	2804 (22.5mm)	18 mm	curvo	2804 (22.5mm)	27 mm
recto	2809 (22.5mm)	18 mm	recto	2809 (22.5mm)	27 mm
curvo	2824 (26mm)	15.5 mm	curvo	2824 (26mm)	25 mm
curvo	2805 (29mm)	11.5 mm	curvo	2805 (29mm)	21 mm
recto	2810 (29mm)	11.5 mm	recto	2810 (29mm)	21 mm
curvo	2813 (35mm)	5.5 mm	curvo	2813 (35mm)	15 mm
recto	2812 (35mm)	5.5 mm	recto	2812 (35mm)	15 mm
			recto	2827 (38mm)	12 mm

Junquillos grapa para junquillos curvos						
Junquillos curvos						
2801	2802	2803	2804	2805	2813	2824
2811	2821	2819	2820	2822	2823	2825
Junquillos grapa						

CORREDERA DOMO 85RT

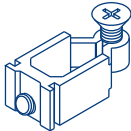
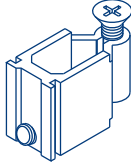
 50uds / bolsa x ud	<p>Ref. 30669</p> <p>Ruleta simple 1 rueda</p> <p>Peso máximo admisible: Por ruleta simple 40Kg Por hoja 80Kg</p>	250uds / caja	 <p>Ref. 30180</p> <p>Escuadra de tetón 24x14</p>
50uds / bolsa x ud	 <p>Ref. 30668</p> <p>Ruleta tandem 2 ruedas</p> <p>Peso máximo admisible: Por ruleta tandem 60Kg Por hoja 120Kg</p>	250uds / caja	 <p>Ref. 30185</p> <p>Escuadra de tetón 17x14</p>
150jgos / caja x ud	 <p>Ref. 30400</p> <p>Juego tapas cruce</p>	250uds / caja	 <p>Ref. 30186</p> <p>Escuadra de tetón 14x12</p>
x ud	 <p>Ref. 30410</p> <p>Juego tapas refuerzo</p>	250uds / bolsa	 <p>Ref. 30628</p> <p>Escuadra de vértice 9x14</p>
x ud	 <p>Ref. 30121</p> <p>Cortavientos sup / inf</p>	100uds / bolsa 500uds / bolsa	 <p>Ref. 30190</p> <p>Escuadra de alineación 15x5x0.8</p>
x ud	<p>Ref. 30543</p> <p>Cierre de embutir negro</p>  <p>Ref. 30542</p> <p>Cierre de embutir blanco</p>	x ud	 <p>Ref. 30677</p> <p>Gancho marco perimetral superpuesto</p>  <p>Ref. 30678</p> <p>Gancho hoja</p>

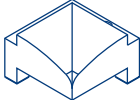
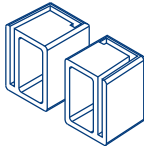
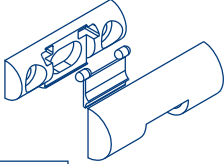
CORREDERA DOMO 85RT

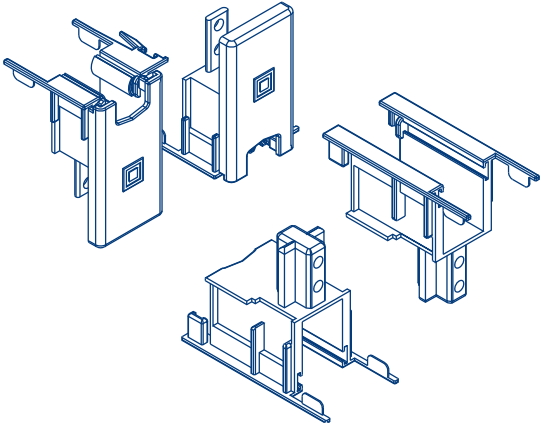
 <p>Ref. 31069 Junta flocada 7x6</p>	 <p>Ref. 30709 Cepillo 7x7</p> <p>225ml / rollo</p>
 <p>Ref. 30630 Tope de zanca ventana 14x18</p> <p>300uds / caja</p>	 <p>Ref. 30635 Tope de zanca puerta 25x18</p> <p>300uds / caja</p>
 <p>Ref. 30645 Grapa de ajuquillar</p> <p>200uds / bolsa</p>	 <p>Ref. 30311 crudo 30312 blanco 30313 negro Esquinero junquillo redondo</p> <p>100uds / bolsa</p>
 <p>Ref. 30211 Juego tapa condensación</p> <p>50jgos / bolsa</p>	 <p>Ref. 30375 Desagüe con válvula negra</p> <p>x ud</p>
 <p>Ref. 30310 Amortiguador lateral</p> <p>80uds / bolsa</p>	<p>Ref. 30372 Desagüe DOMO 85RT corte recto</p>
 <p>Ref. 30411 Juegos tapas hojas DOMO 85RT corte recto</p>	

CORREDERA DOMO 85RT

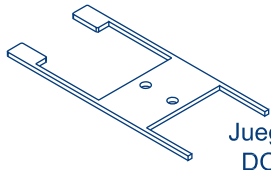
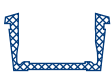
 <p>Ref. 30265</p> <p>Juego juntas estanqueidad DOMO 85RT corte recto</p> <p>1 Juego (4uds)</p>	<p>Ref. 30127</p> <p>Cortavientos sup / inf DOMO 85RT corte recto</p>
 <p>Ref. 31068</p> <p>Junta acristalar DOMO 85RT corte recto</p>	

CORREDERA DOMO 85RT

DOMO 80 - 85RT PERIMETRALES

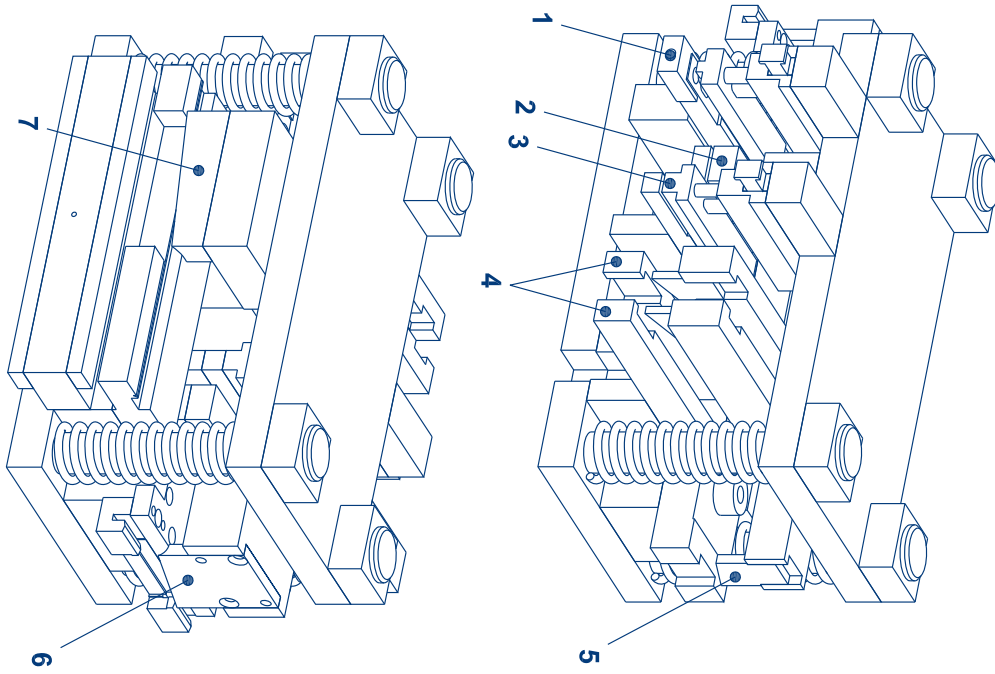

<p>1.- MECANIZADO ESCUADRA.</p>	<p>2.- MECANIZADO ESCUADRA HOJA SIN RPT.</p>
<p>3.- MECANIZADO ESCUADRA PERFILES:</p>	<p>4.- MECANIZADO DESAGÜE CAMARA.</p>
<p>5.- MECANIZADO DESAGÜE CARRIL.</p>	<p>6.- MECANIZADO ALOJAMIENTO GATILLO.</p>
<p>7.- MECANIZADO CIERRE (2 CORTES).</p> <p>GIRAR SUPLEMENTO (POSICION ALTA S/ 80 , POSICION BAJA S/ 85 RT)</p>	<p>ACOPLAR SUPL. FRONTAL PARA S/ 85 RT</p>

CORREDERA DOMO 85RT

DOMO 85RT CORTE RECTO

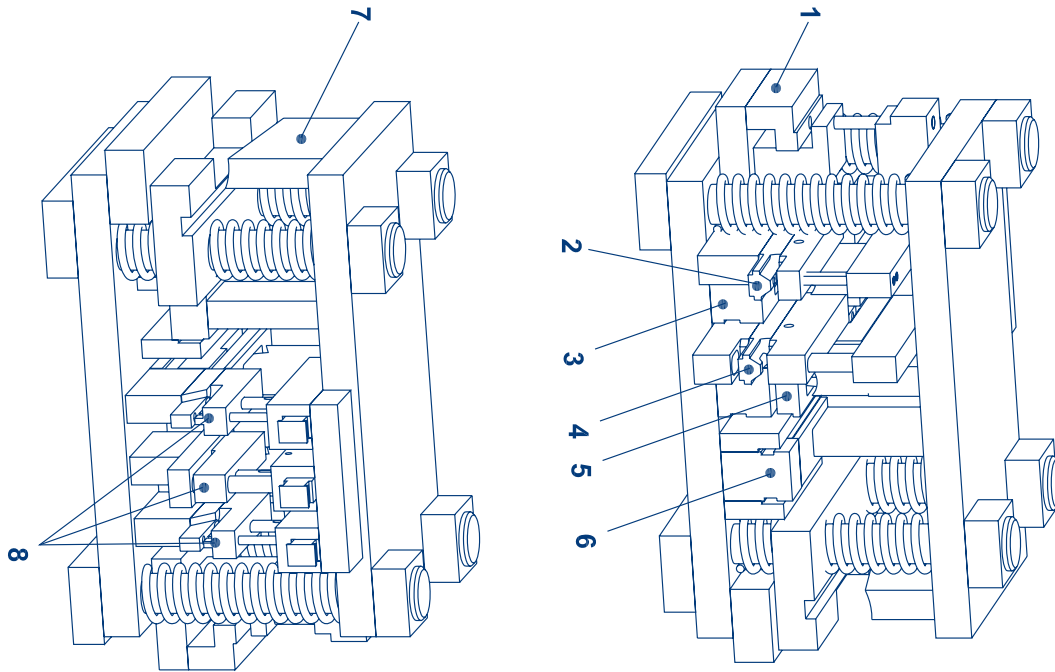

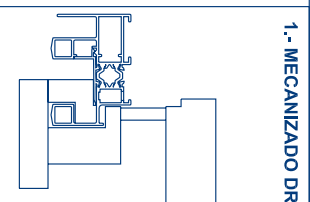
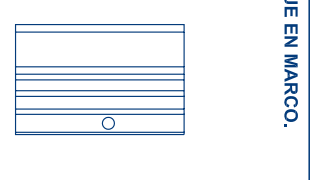
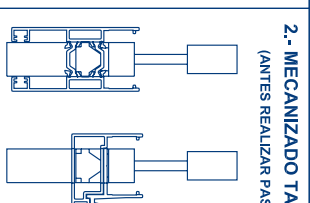
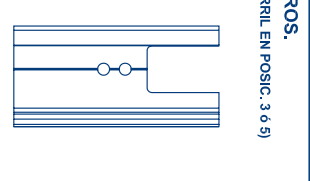
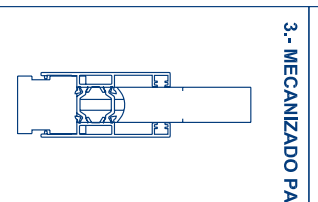
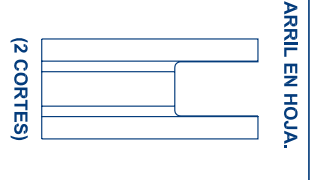
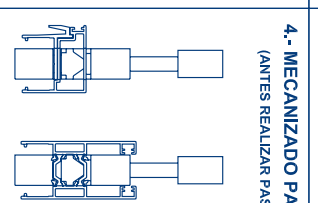
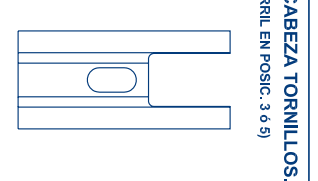
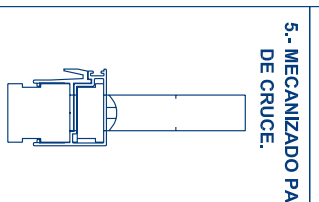
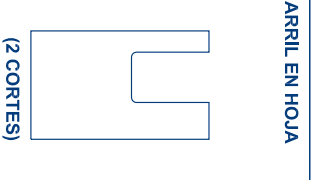
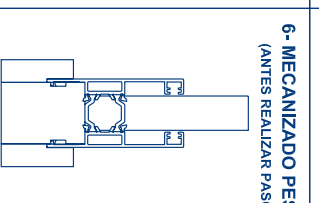
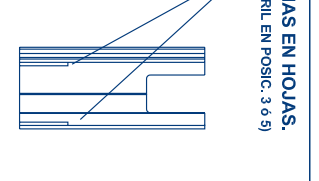
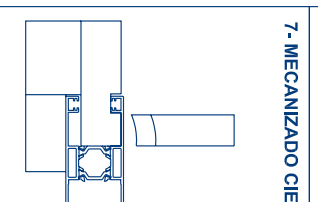
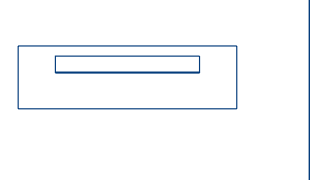
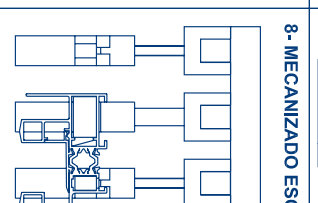
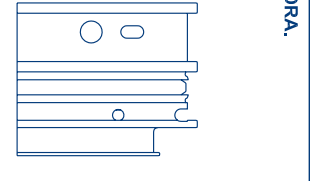
<p>1.- MECANIZADO DRENAJE EN MARCO.</p>  	<p>2.- MECANIZADO TALADROS. (ANTES REALIZAR PASO CARRIL EN POSIC. 3 ó 5)</p>  
<p>3.- MECANIZADO PASO CARRIL EN HOJA.</p>  	<p>4.- MECANIZADO PASO CABEZA TORNILLLOS. (ANTES REALIZAR PASO CARRIL EN POSIC. 3 ó 5)</p>  
<p>5.- MECANIZADO PASO CARRIL EN HOJA DE CRUCE.</p>  	<p>6.- MECANIZADO PESTAÑAS EN HOJAS. (ANTES REALIZAR PASO CARRIL EN POSIC. 3 ó 5)</p>  
<p>7.- MECANIZADO CIERRE.</p>  	<p>8.- MECANIZADO ESCUADRA.</p>  

CORREDERA DOMO 85RT

Ventana 2 hojas corte recto

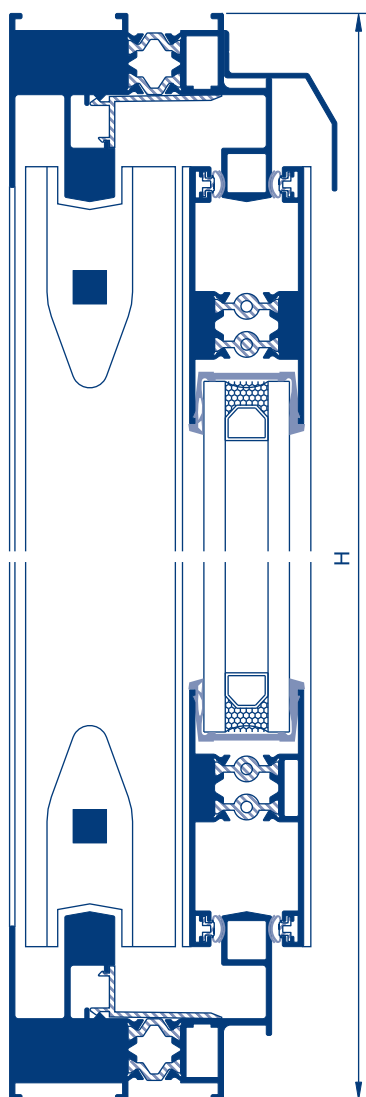
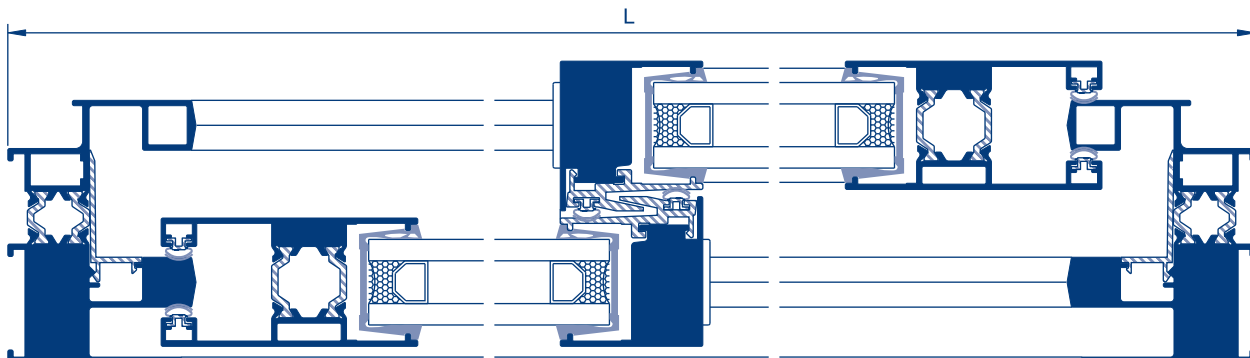

	Ref.	Descripción	Horizontal			Vertical		
			Corte	Cantidad	Medida	Corte	Cantidad	Medida
	3470	Marco perimetral		2	L		2	H
	3471	Hoja de ruedas		4	L - 48			
	3472	Hoja lateral					2	H - 43
	3473	Hoja central					2	H - 43
	31206	Cruce hojas (perfil termoplástico)					2	H - 43
	31201	Tapamarco (perfil termoplástico)		2	L		2	H
	3477	Vierteaguas		1	L			



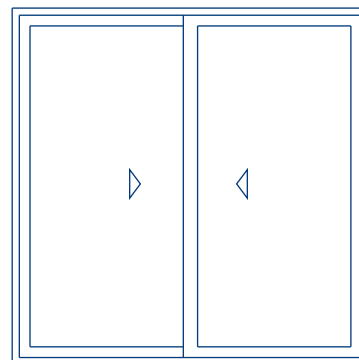





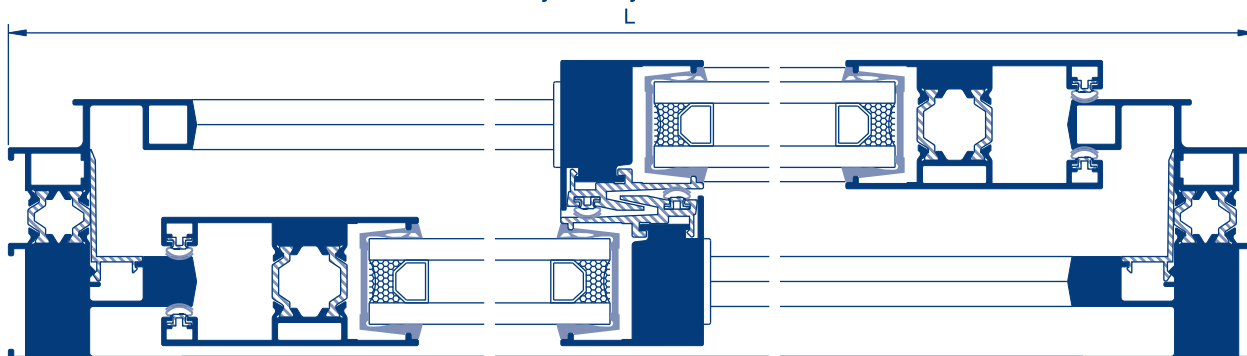















Ref.	Descripción	Cantidad	Medida
30180	Escuadra marco	4	
30628	Escuadra marco	4	
30543	Cierre con cerradero	2	
30677	Gancho marco	2	
30678	Gancho hoja	2	
30668	Rodamientos	4	
30411	Juego tapas hojas	2	
30265	Juego juntas estanqueidad	2	
31069	Junta flocada Junta flocada	4 6	L H
30127	Cortavientos	2	
30372	Desagües	2	



CORREDERA DOMO 85RT

Ventana 2 hojas + fijo inferior corte recto



	Ref.	Descripción	Horizontal			Vertical		
			Corte	Cantidad	Medida	Corte	Cantidad	Medida
	3470	Marco perimetral		2	L		2	H1
	3471	Hoja de ruedas		4	L - 48			
	3472	Hoja lateral					2	H1 - 43
	3473	Hoja central					2	H1 - 43
	31206	Cruce hojas (perfil termoplástico)					2	H1 - 43
	31201	Tapamarco (perfil termoplástico)		2	L		2	H1
	3477	Vierteaguas		1	L			
	3475	Marco fijo		2	L		2	(H - H1)-2
	3476	Unión de marcos		2	L			
		Junquillo		2	L - 56		2	(H-H1)-102
	Ref.	Descripción	Cantidad	Medida				
	30180	Escuadra marco y fijo	8					
	30628	Escuadra marco y fijo	4					
	30543	Cierre con cerradero	2					
	30677	Gancho marco	2					
	30678	Gancho hoja	2					
	30668	Rodamientos	4					
	30411	Juego tapas hojas	2					
	30265	Juego juntas estanqueidad	2					
	31069	Junta flocada	4	L				
		Junta flocada	6	H				
	30127	Cortavientos	2					
	30372	Desagües						

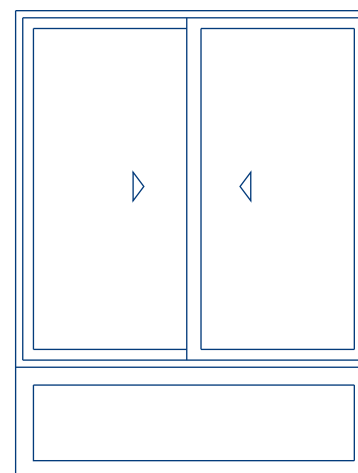

CORREDERA DOMO 85RT

Ventana 2 hojas con refuerzo corte recto

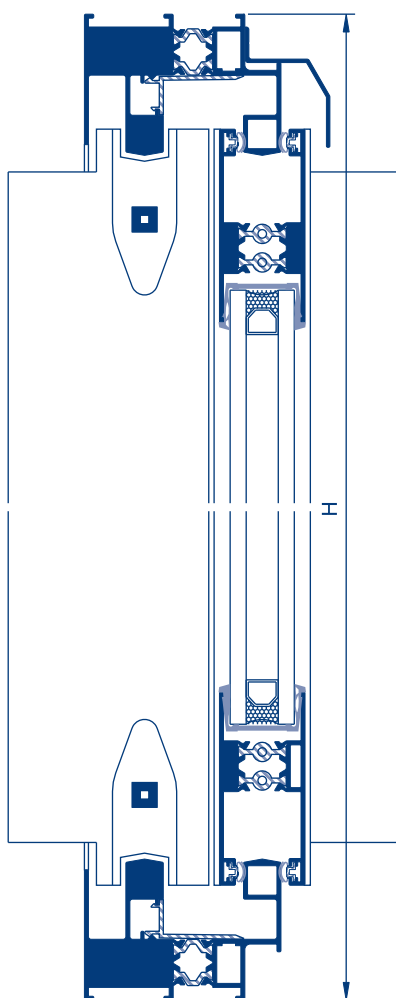
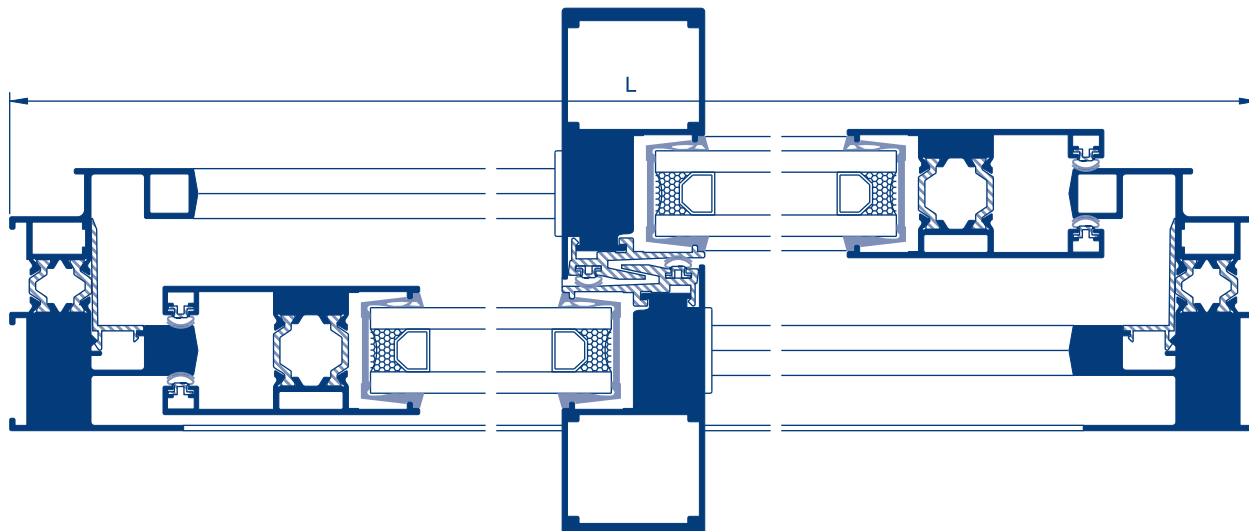

	Ref.	Descripción	Horizontal			Vertical		
			Corte	Cantidad	Medida	Corte	Cantidad	Medida
	3470	Marco perimetral		2	L		2	H
	3471	Hoja de ruedas		4	L - 48			
	3472	Hoja lateral					2	H - 43
	3474	Hoja central con refuerzo					2	H - 43
	31206	Cruce hojas (perfil termoplástico)					2	H - 43
	31201	Tapamarco (perfil termoplástico)		2	L		2	H
	3477	Vierteaguas		1	L			

Ref.	Descripción	Cantidad	Medida
30180	Escuadra marco	4	
30628	Escuadra marco	4	
30543	Cierre con cerradero	2	
30677	Gancho marco	2	
30678	Gancho hoja	2	
30668	Rodamientos	4	
30411	Juego tapas hojas	2	
30265	Juego juntas estanqueidad	2	
31069	Junta flocada Junta flocada	4 6	L H
30127	Cortavientos	2	
30372	Desagües		

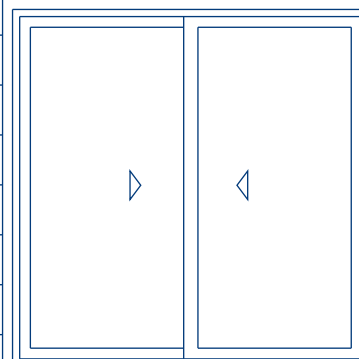

CORREDERA DOMO 85RT

Ventana 2 hojas marco 3401 y hoja 3405

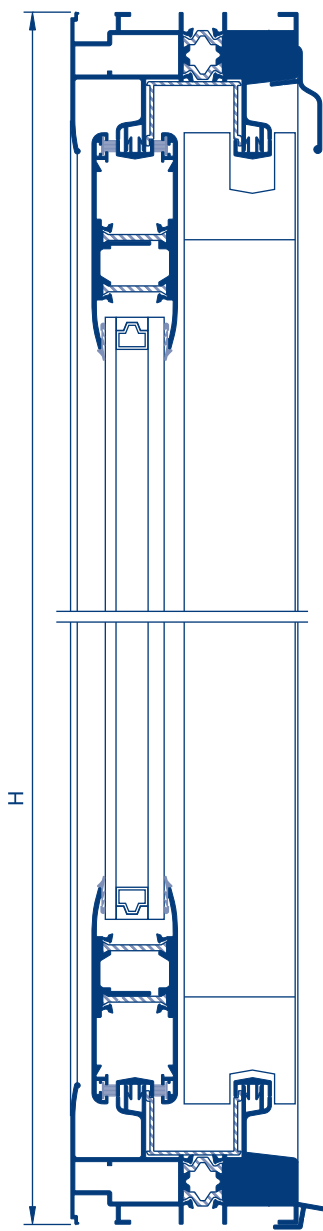
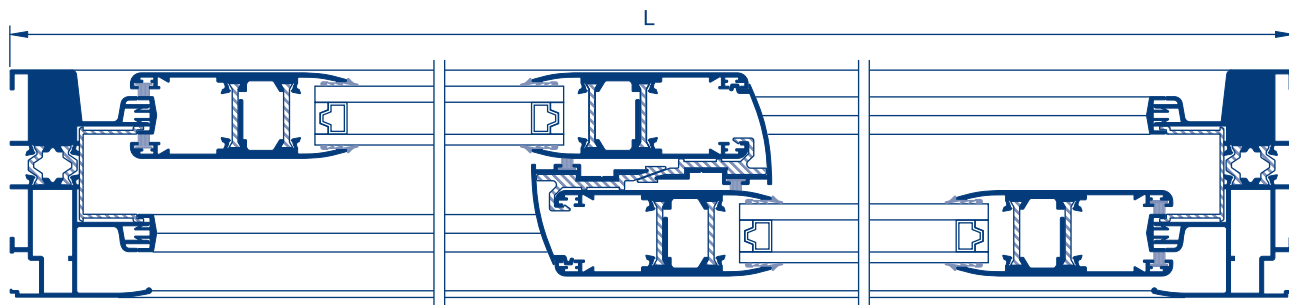

	Ref.	Descripción	Horizontal			Vertical		
			Corte	Cantidad	Medida	Corte	Cantidad	Medida
	3401	Marco perimetral		2	L		2	H
	3402	Bandeja 61 mm.		1	L			
	31205	Cruce hojas (perfil termoplástico)					2	H - 170
	3405	Hoja perimetral		4	L/2 - 6		4	H - 90
	3407	Guia de rodadura		4	L		4	H
	3409	Cruce de hojas					2	H - 170
	31200	Tapamarco (perfil termoplástico)		2	L		2	H
	3412	Vierteaguas		1	L			

Ref.	Descripción	Cantidad	Medida
30180	Escuadra marco	8	
30185	Escuadra hoja	8	
30190	Escuadra alineamiento hoja	16	
30543	Cierre con cerradero	2	
30677	Gancho marco	2	
30678	Gancho hoja	2	
30400	Juego tapas hoja centro	2	
30709	Cepillo 7x7	4	L
		6	H
30121	Cortavientos	2	
30668	Rodamientos	4	
30375	Desagües	2	

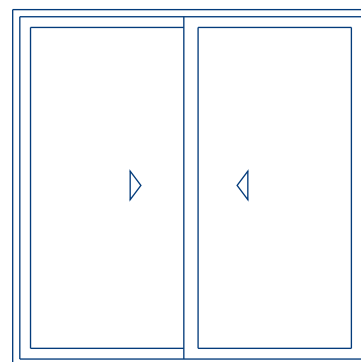

CORREDERA DOMO 85RT

Ventana 2 hojas con fijo inferior, marco 3401 y hoja 3405

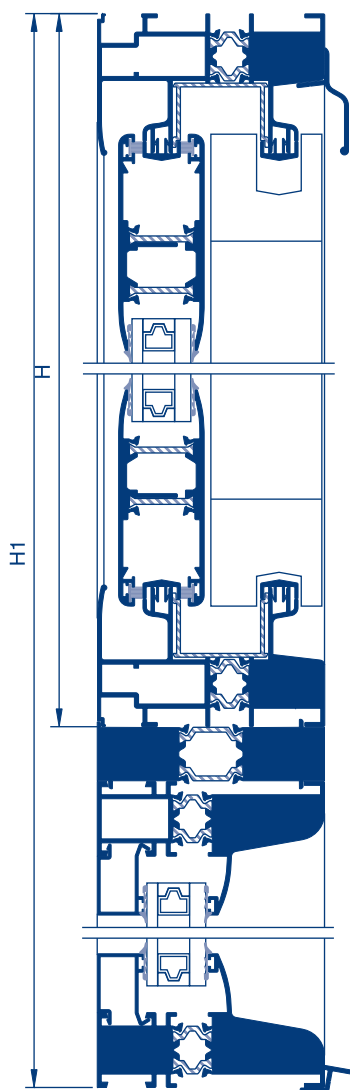
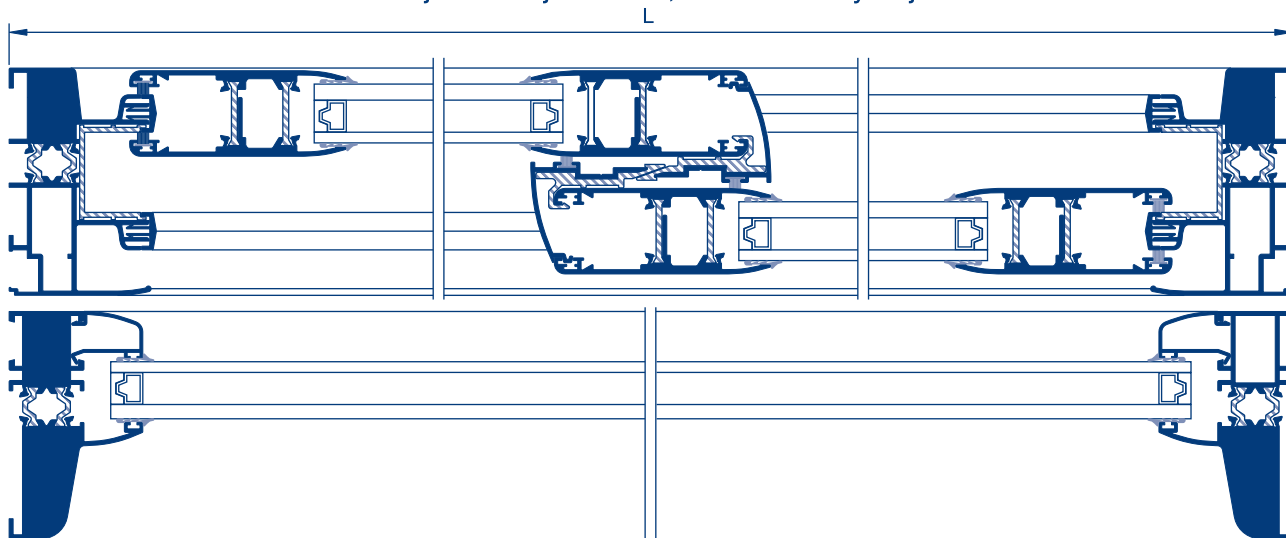

	Ref.	Descripción	Horizontal			Vertical		
			Corte	Cantidad	Medida	Corte	Cantidad	Medida
	3401	Marco perimetral		2	L		2	H
	3402	Bandeja 61 mm.		1	L			
	31205	Cruce hojas (perfil termoplástico)					2	H - 170
	3405	Hoja perimetral		4	L/2 - 6		4	H - 90
	3407	Guía de rodadura		4	L		4	H
	3409	Cruce de hojas					2	H - 170
	31200	Tapamarco (perfil termoplástico)		2	L		2	H
	3412	Vierteaguas		1	L			
	3400	Unión de marco y fijo		1	L			
	3408	Marco fijo		2	L		2	(H1 - H)-20
		Junquillos corte recto		2	L - 56		2	(H1 - H)-120
		Junquillos corte inglete		2	L - 56		2	(H1 - H)-76

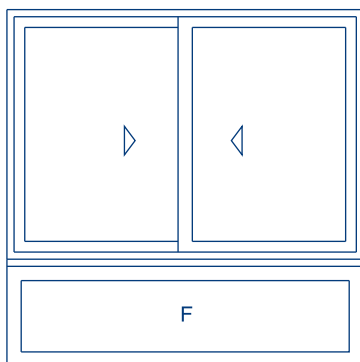

Ref.	Descripción	Cantidad	Medida
30180	Escuadra marco	16	
30185	Escuadra hoja	8	
30190	Escuadra alineamiento hoja	16	
30543	Cierre con cerradero	2	
30677	Gancho marco	2	
30678	Gancho hoja	2	
30400	Juego tapas hoja centro	2	
30709	Cepillo (7x7)	4 6	L H
30121	Cortavientos	2	
30668	Rodamientos	4	
30375	Desagües	2	

CORREDERA DOMO 85RT

Ventana 2 hojas con refuerzo, marco 3401 y hoja 3405

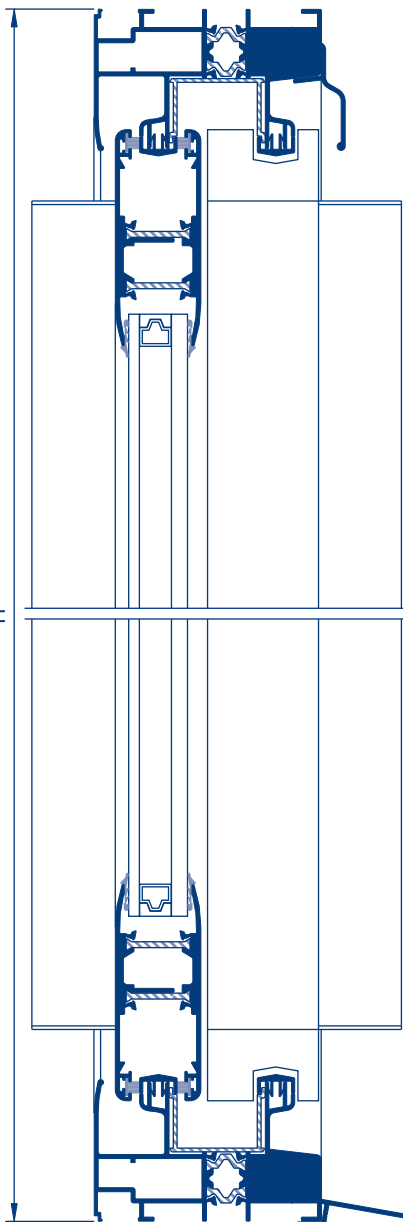
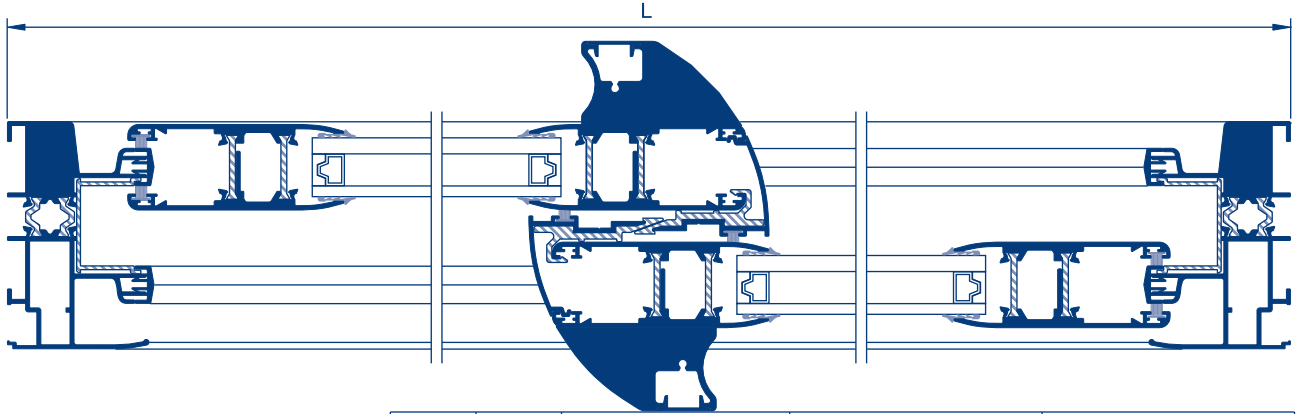

Ref.	Descripción	Horizontal			Vertical		
		Corte	Cantidad	Medida	Corte	Cantidad	Medida
3401	Marco perimetral		2	L		2	H
3402	Bandeja 61 mm.		1	L			
31205	Cruce hojas (perfil termoplástico)					2	H - 170
3405	Hoja perimetral		4	L/2 - 6		4	H - 90
3407	Guia de rodadura		4	L		4	H
3409	Cruce de hojas					2	H - 170
31200	Tapamarco (perfil termoplástico)		2	L		2	H
3412	Vierteaguas		1	L			
3404	Refuerzo hoja					2	H - 150
2605	Tapa refuerzo hoja					2	H - 150

Ref.	Descripción	Cantidad	Medida
30180	Escuadra marco	8	
30185	Escuadra hoja	8	
30190	Escuadra alineamiento hoja	16	
30543	Cierre con cerradero	2	
30677	Gancho marco	2	
30678	Gancho hoja	2	
30400	Juego tapas hoja centro	2	
30709	Cepillo (7x7)	4 6	L H
30410	Juego tapas refuerzo hoja	2	
30121	Cortavientos	2	
30668	Rodamientos	4	
30375	Desagües	2	

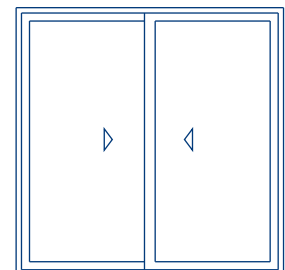

CORREDERA DOMO 85RT

Ventana 2 hojas marco 3413 y hoja 3405

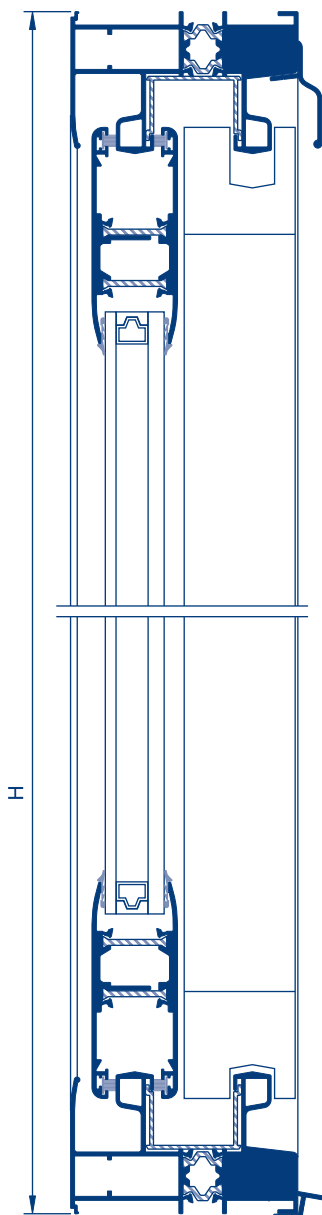
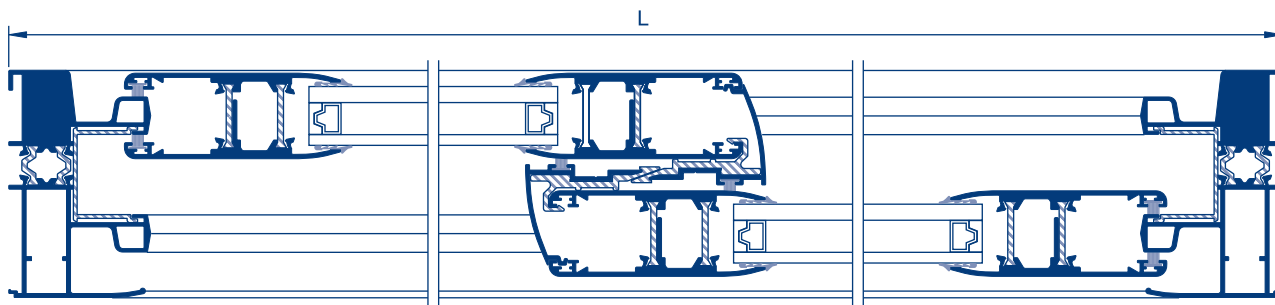

	Ref.	Descripción	Horizontal			Vertical		
			Corte	Cantidad	Medida	Corte	Cantidad	Medida
	3413	Marco perimetral		2	L		2	H
	3402	Bandeja 61 mm.		1	L			
	31205	Cruce hojas (perfil termoplástico)					2	H - 166
	3405	Hoja perimetral		4	L/2 - 7		4	H - 86
	3409	Cruce de hojas					2	H - 166
	31200	Tapamarco (perfil termoplástico)		2	L		2	H
	3412	Vierteaguas		1	L			

Ref.	Descripción	Cantidad	Medida
30180	Escuadra marco	8	
30185	Escuadra hoja	8	
30190	Escuadra alineamiento hoja	16	
30543	Cierre con cerradero	2	
30677	Gancho marco	2	
30678	Gancho hoja	2	
30400	Juego tapas hoja centro	2	
30709	Cepillo 7x7	4	L
		6	H
30121	Cortavientos	2	
30668	Rodamientos	4	
30375	Desagües	2	

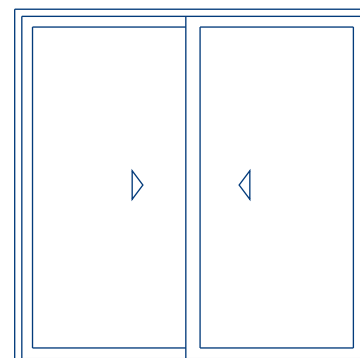

CORREDERA DOMO 85RT

Ventana 2 hojas marco 3436 y hoja 3405

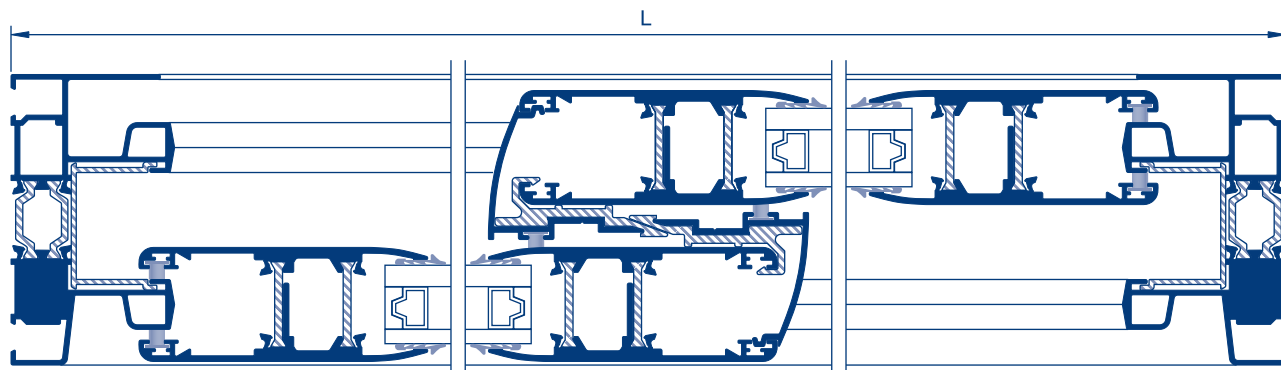

	Ref.	Descripción	Horizontal			Vertical		
			Corte	Cantidad	Medida	Corte	Cantidad	Medida
	3436	Marco perimetral		2	L		2	H
	3402	Bandeja 61 mm.		1	L			
	31205	Cruce hojas (perfil termoplástico)					2	H - 152
	3405	Hoja perimetral		4	L / 2		2	H - 72
	3409	Cruce de hojas					2	H - 152
	31200	Tapamarco (perfil termoplástico)		2	L		2	H
	3412	Vierteaguas		1	L			

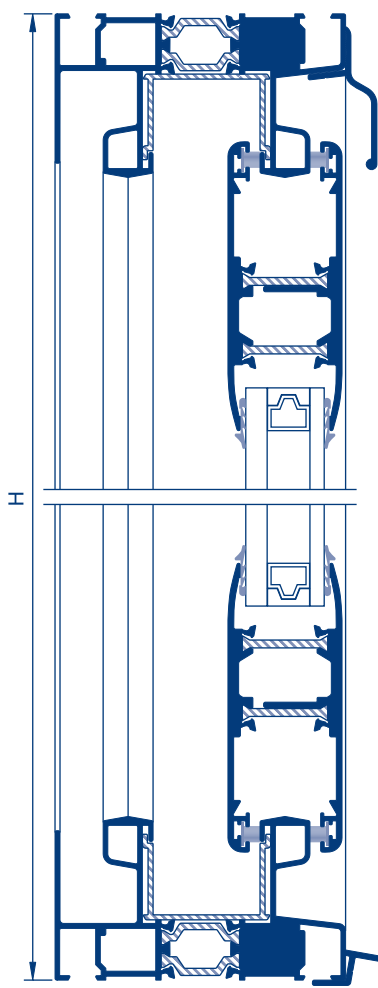



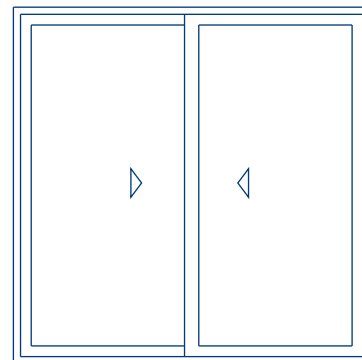



Ref.	Descripción	Cantidad	Medida
30186	Escuadra marco	8	
30185	Escuadra hoja	8	
30190	Escuadra alineamiento hoja	16	
30543	Cierre con cerradero	2	
30677	Gancho marco	2	
30678	Gancho hoja	2	
30400	Juego tapas hoja centro	2	
30709	Cepillo (7x7)	4	L
		6	H
30121	Cortavientos	2	
30668	Rodamientos	4	
30375	Desagües	2	

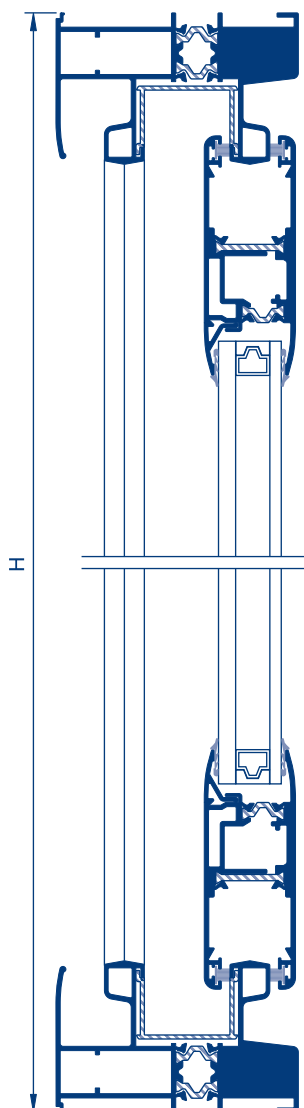
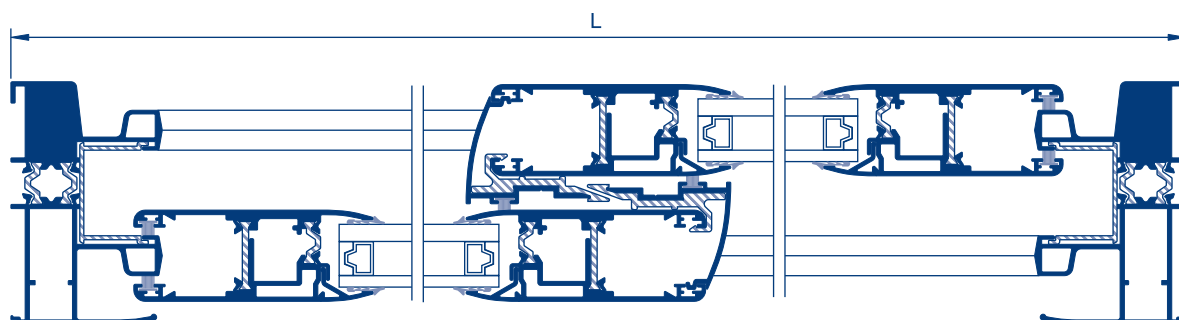

CORREDERA DOMO 85RT

Ventana 2 hojas marco 3413 y hoja 3422



	Ref.	Descripción	Horizontal			Vertical		
			Corte	Cantidad	Medida	Corte	Cantidad	Medida
	3413	Marco perimetral		2	L		2	H
	3422	Hoja perimetral		4	L/2 - 5		4	H - 86
	3419	Junquillo		4	L/2 - 137		4	H - 217
	31205	Cruce hojas (perfil termoplástico)					2	H - 166
	3409	Cruce de hojas					2	H - 166
	31200	Tapamarco (perfil termoplástico)		2	L		2	H

Ref.	Descripción	Cantidad	Medida
30180	Escuadra marco	8	
30185	Escuadra hoja	8	
30190	Escuadra alineamiento hoja	16	
30543	Cierre con cerradero	2	
30677	Gancho marco	2	
30678	Gancho hoja	2	
30400	Juego tapas hoja centro	2	
30709	Cepillo (7x7)	4 6	L H
30121	Cortavientos	2	
30668	Rodamientos	4	
30375	Desagües	2	

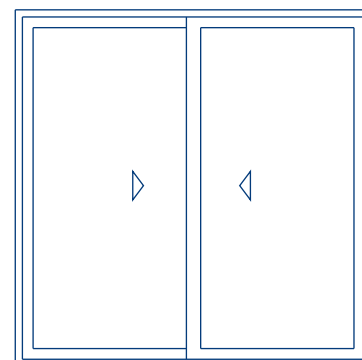

CORREDERA DOMO 85RT

Ventana 2 hojas marco 3436 y hoja 3429

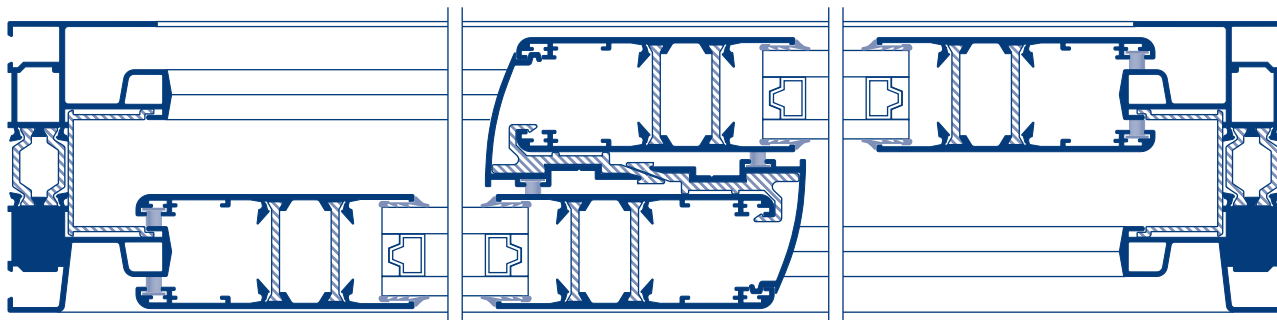

	Ref.	Descripción	Horizontal			Vertical		
			Corte	Cantidad	Medida	Corte	Cantidad	Medida
	3436	Marco perimetral		2	L		2	H
	3402	Bandeja 61 mm.		1	L			
	31205	Cruce hojas (perfil termoplástico)					2	H - 152
	3429	Hoja perimetral		4	L / 2		2	H - 72
	3409	Cruce de hojas					2	H - 152
	31200	Tapamarco (perfil termoplástico)		2	L		2	H
	3412	Vierteaguas		1	L			

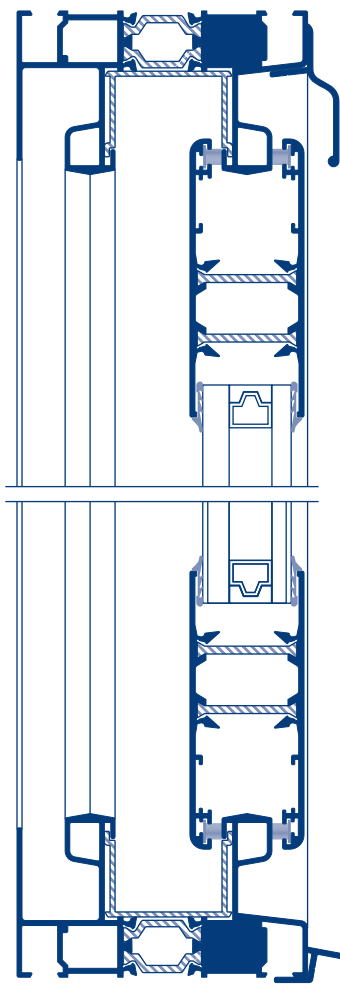



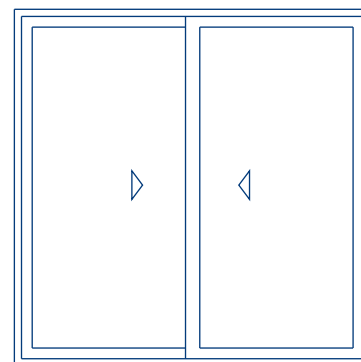





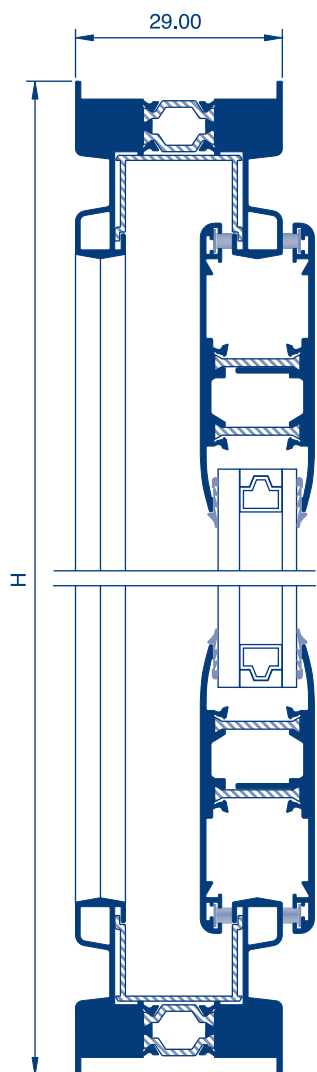
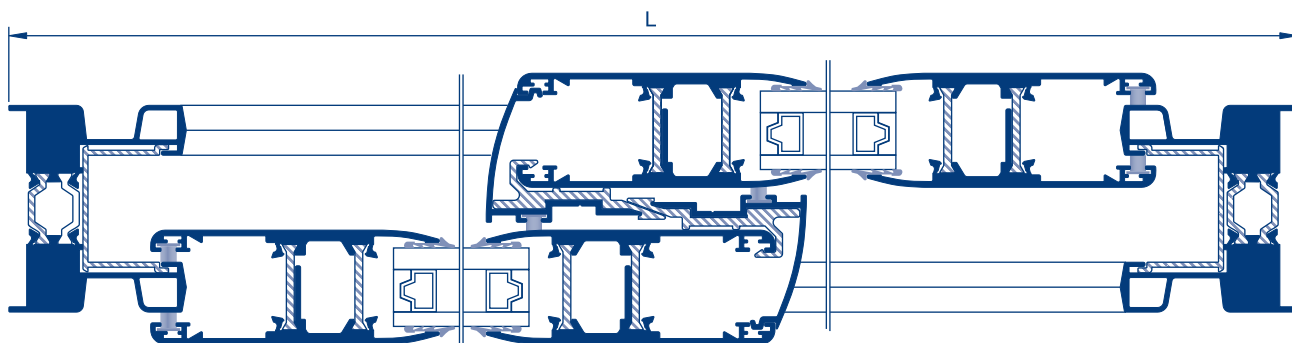





Ref.	Descripción	Cantidad	Medida
30186	Escuadra marco	8	
30174	Escuadra hoja	8	
30190	Escuadra alineamiento hoja	16	
30200	Escuadra alineamiento hoja	16	
30543	Cierre con cerradero	2	
30677	Gancho marco	2	
30678	Gancho hoja	2	
30400	Juego tapas hoja centro	2	
30709	Cepillo (7x7)	4 6	L H
30121	Cortavientos	2	
30668	Rodamientos	4	
30375	Desagües	2	



CORREDERA DOMO 85RT

Ventana 2 hojas marco 3437 y hoja 3405



	Ref.	Descripción	Horizontal			Vertical		
			Corte	Cantidad	Medida	Corte	Cantidad	Medida
	3437	Marco perimetral		2	L		2	H
	31205	Cruce hojas (perfil termoplástico)					2	H - 160
	3405	Hoja perimetral		4	L/2 - 4		4	H - 80
	3409	Cruce de hojas					2	H - 160
	31200	Tapamarco (perfil termoplástico)		2	L		2	H



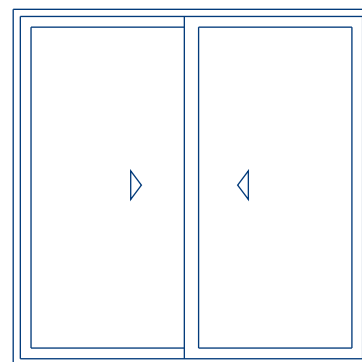



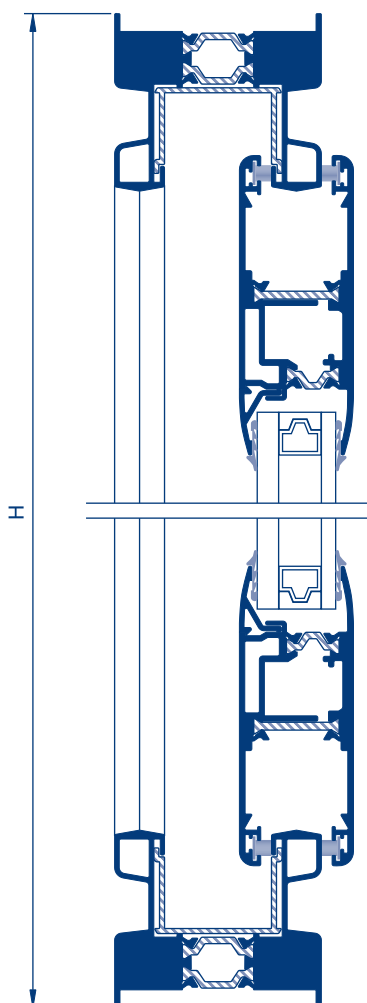
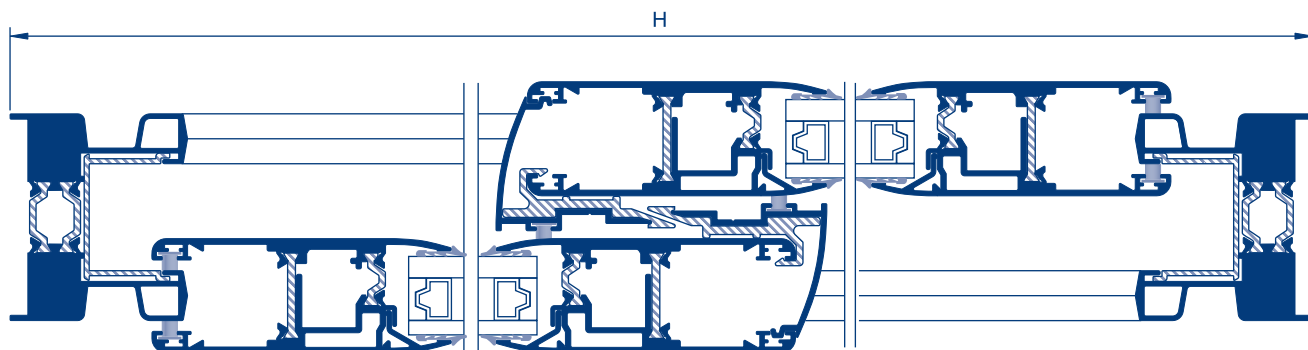

Ref.	Descripción	Cantidad	Medida
30186	Escuadra marco	8	
30185	Escuadra hoja	8	
30190	Escuadra alineamiento hoja	16	
30543	Cierre con cerradero	2	
30677	Gancho marco	2	
30678	Gancho hoja	2	
30400	Juego tapas hoja centro	2	
30709	Cepillo (7x7)	4 6	L H
30121	Cortavientos	2	
30668	Rodamientos	4	
30375	Desagües	2	



CORREDERA DOMO 85RT

Ventana 2 hojas marco 3437 y hoja 3422



	Ref.	Descripción	Horizontal			Vertical		
			Corte	Cantidad	Medida	Corte	Cantidad	Medida
	3437	Marco perimetral		2	L		2	H
	31205	Cruce hojas (perfil termoplástico)					2	H - 160
	3422	Hoja perimetral		4	L/2 - 2		4	H - 80
	3419	Junquillo		4	L/2 - 133		4	H - 211
	3409	Cruce de hojas					2	H - 160
	31200	Tapamarco (perfil termoplástico)		2	L		2	H

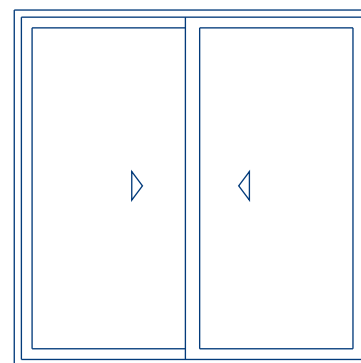

Ref.	Descripción	Cantidad	Medida
30186	Escuadra marco	8	
30185	Escuadra hoja	8	
30190	Escuadra alineamiento hoja	16	
30543	Cierre con cerradero	2	
30677	Gancho marco	2	
30678	Gancho hoja	2	
30400	Juego tapas hoja centro	2	
30709	Cepillo (7x7)	4	L H
30121	Cortavientos	2	
30668	Rodamientos	4	
30375	Desagües	4	

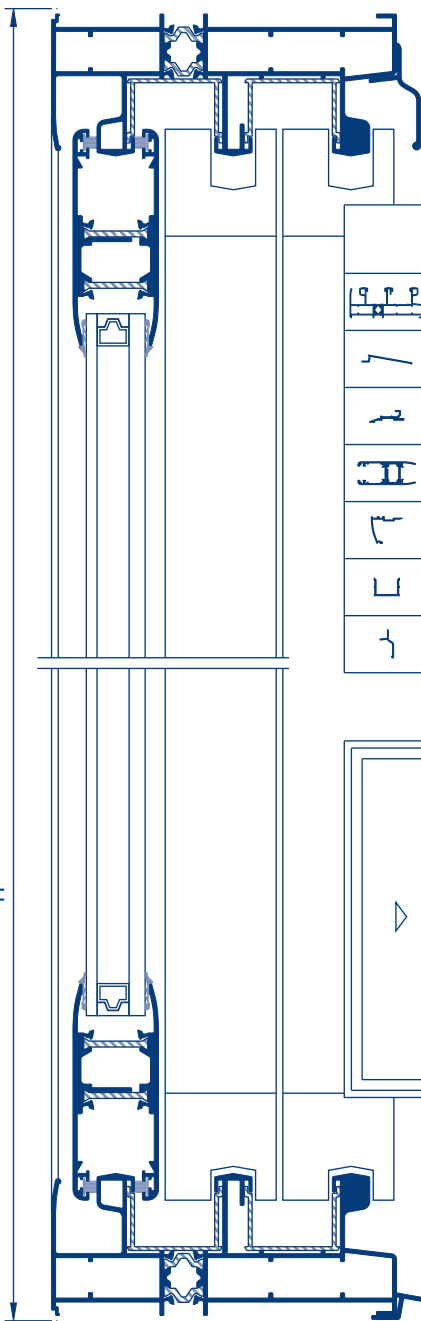
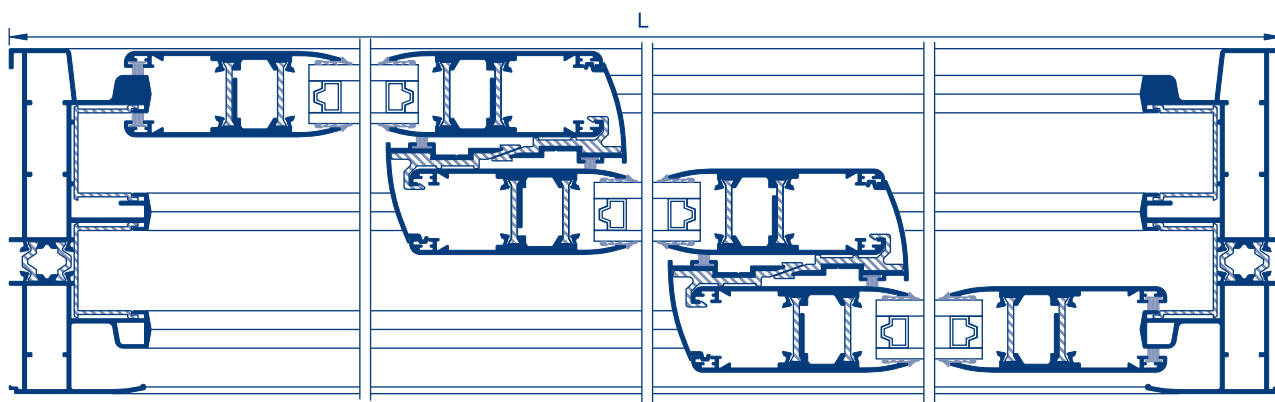

CORREDERA DOMO 85RT

Ventana 3 hojas



	Ref.	Descripción	Horizontal			Vertical		
			Corte	Cantidad	Medida	Corte	Cantidad	Medida
	3452	Marco perim. 3 carriles		2	L		2	H
	3402	Bandeja 61 mm.		1	L			
	31205	Cruce hojas (perfil termoplástico)					4	H - 170
	3405	Hoja perimetral		6	L/3 + 20		6	H - 90
	3409	Cruce de hojas					4	H - 170
	31200	Tapamarco (perfil termoplástico)		2	L		2	H
	3412	Vierteaguas		1	L			





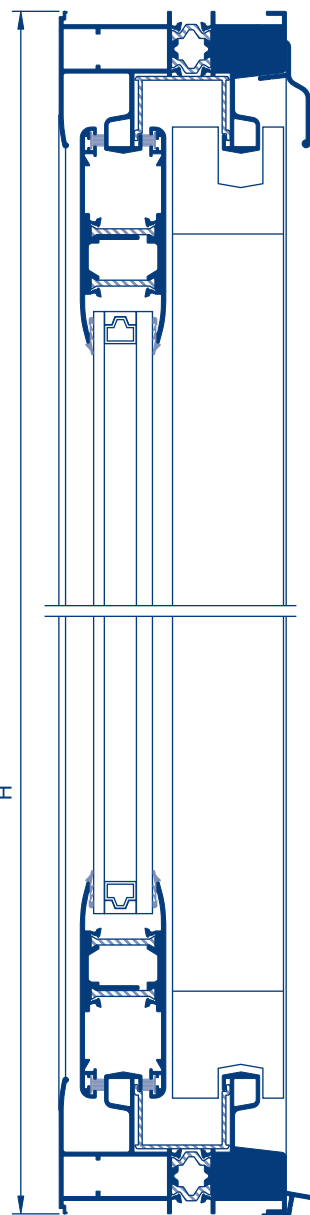
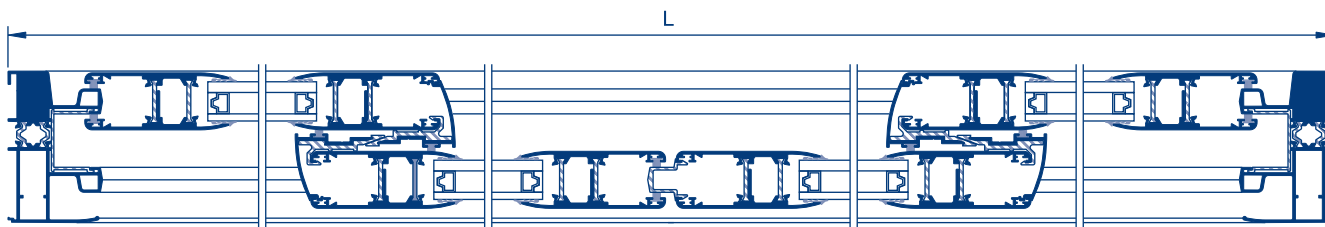

Ref.	Descripción	Cantidad	Medida
30180	Escuadra marco	8	
30185	Escuadra hoja	12	
30190	Escuadra alineamiento hoja	24	
30543	Cierre con cerradero	2	
30677	Gancho marco	2	
30678	Gancho hoja	2	
30400	Juego tapas hoja centro	4	
30709	Cepillo (7x7) Cepillo (7x7)	4 8	L H
30121	Cortavientos	4	
30668	Rodamientos	6	

Ctra. Estación, s/n • 36720 GUILLAREI - TUI (Pontevedra)
Teléfono 986 607 133 • Fax 986 607 134

CORREDERA DOMO 85RT

Ventana 4 hojas



	Ref.	Descripción	Horizontal			Vertical		
			Corte	Cantidad	Medida	Corte	Cantidad	Medida
	3413	Marco perimetral		2	L		2	H
	3402	Bandeja 61 mm.		1	L			
	31205	Cruce hojas (perfil termoplástico)					4	H - 146
	3405	Hoja perimetral		8	L/4 + 13		8	H - 86
	31235	Perfil unión 4 hojas (perfil termoplástico)					1	H - 86
	3409	Cruce de hojas					4	H - 146
	31200	Tapamarco (perfil termoplástico)		2	L		2	H
	3412	Vierteaguas		1	L			

Ref.	Descripción	Cantidad	Medida
30180	Escuadra marco	8	
30185	Escuadra hoja	16	
30190	Escuadra alineamiento hoja	32	
30543	Cierre con cerradero	3	
30677	Gancho marco	3	
30678	Gancho hoja	3	
30400	Juego tapas hoja centro	4	
30709	Cepillo (7x7) Cepillo (7x7)	4 8	L H
30121	Cortavientos	4	
30668	Rodamientos	8	

